

User's Manual

STAGE PIANO

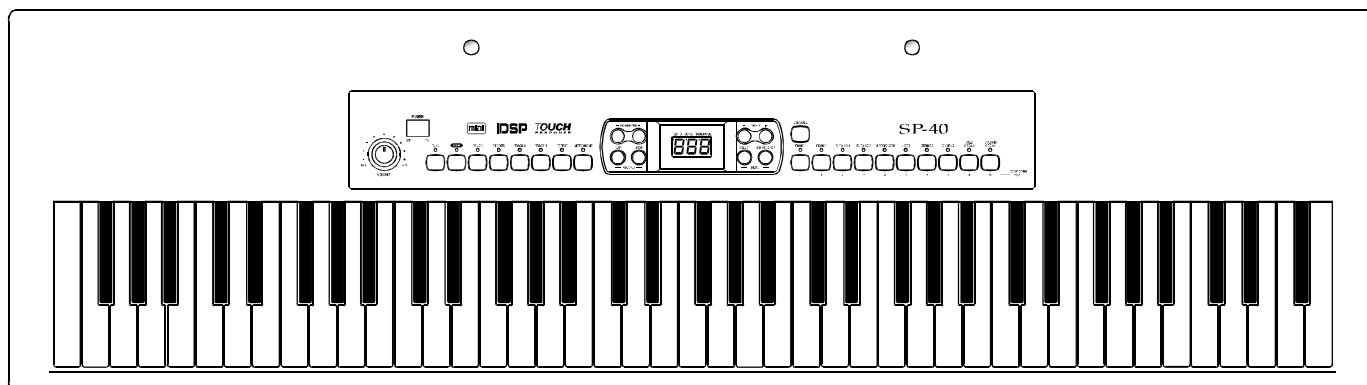

Using the Instruction Manual

Thank you for purchasing this Digital Piano. The use of high technology and the most advanced sampling technique brings you high quality sound and enjoyment. The combination of digital piano and electronic keyboard features let you perform perfectly. We hope this digital piano will be able to explore your creativity, and brings you unlimited happiness and music enjoyment.

Before you use the piano, we recommend you to read through this manual. Please keep this instruction manual for future reference.

Precautions

Please read the following carefully before use:

- Do not expose the piano to high temperature, direct sunlight and excessively dusty places.
- Do not place the piano too close to other electrical appliances such as television and radio. It may cause interference.
- Do not place the piano to excessive humid area. Avoid putting container with liquid on top of the piano for preventing the damage of the internal parts of the piano by flowing liquid.
- Always unplug AC cord by gripping the plug firmly, but not pulling on the cable.
- Do not apply excessive force to the switches and buttons.
- When the piano is not in use or in the time of thunderstorm, please disconnect the power supply.
- Avoid adjusting the volume level to the maximum or to the levels that you feel uncomfortable, we recommend you to limit the volume level to two-third of the max for preventing the damage of auditory sense
- Unplug the power cable before cleaning the piano. Do not connect or disconnect the power cable with a wet hand.
- Check and clean the power plug periodically.
- To avoid damage to the piano and other devices to which it is connected, turn the power switches of all related device off prior to connecting or disconnecting cables.
- Clean the piano and remove the dust with a dry soft cloth or a slightly damp cloth.
- Never use cleaners such as thinner or alcohol. To prevent any damage on the surface of the LED display, please use lens cleaning tissue to clean the display.
- If the piano cable is damaged, please do not use the piano. Otherwise it may cause fire or electrical hazard.
- In case of malfunction due to improper handling the piano, please switch off and on again after 30 seconds.
- Do not attempt to disassemble or repair the piano by yourself. If the piano does not work properly, please contact the approved repairer.
- The piano should not be exposed to dripping or splashing. Do not place any object filled with liquids on the piano.

Contents

General Guide	3
The Connectors	4-5
- Using the AC power jack	4
- Using Headphones	4
- Using the AUX.OUT jack	4
- Using the Foot Pedals	5
- Using the MIDI IN/OUT jack	5
Operation	6-10
1. Power Switch & Volume	6
2. Voice/Dual Voice	6
3. Metronome	6
4. DSP (Digital Signal Processor).....	7
5. Transpose.....	7
6. Tempo	7
7. Touch Response	8
8. Record & Playback.....	8-9
9. Demo Song.....	9-10
MIDI	11
- What is MIDI?	11
- What you can do with MIDI?.....	11
Specifications	12
Voice List	13
Demo Song List	13

General Guide

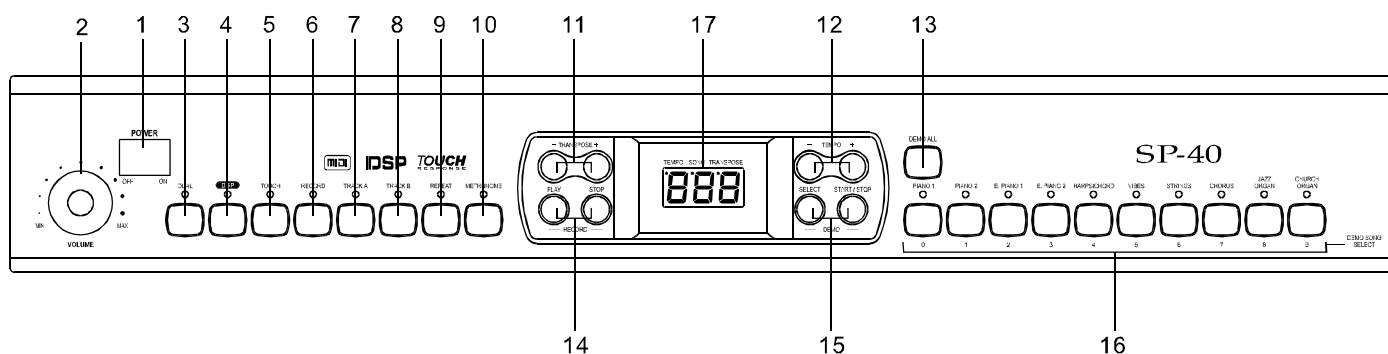

1. FRONT PANEL

- | | |
|--|--|
| <ul style="list-style-type: none"> ❶ POWER SWITCH ❷ MASTER VOLUME ❸ DUAL ❹ DSP ❺ TOUCH ❻ RECORD ❼ TRACK A ❽ TRACK B ❾ REPEAT ❿ METRONOME ⓫ TRANSPOSE +/- ⓬ TEMPO +/- ⓭ DEMO ALL ⓮ RECORD - PLAY - STOP ⓯ DEMO - SELECT - START/STOP | <ul style="list-style-type: none"> ⓰ VOICE TYPE & DEMO SONG SELECT 0 - PIANO 1 1 - PIANO 2 2 - E.PIANO 1 3 - E.PIANO 2 4 - HARPSICHORD 5 - VIBES 6 - STRINGS ENSEMBLE 7 - CHORUS 8 - JAZZ ORGAN 9 - CHURCH ORGAN ⓱ LED - TEMPO - SONG - TRANSPOSE |
|--|--|

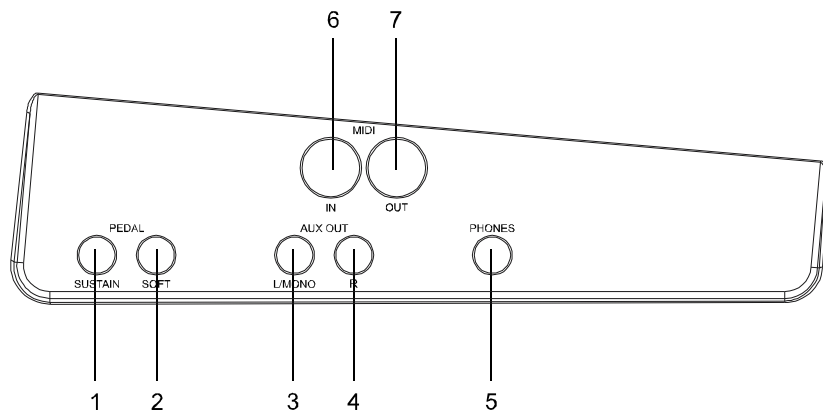

2. LEFT PANEL

- ❶ SUSTAIN PEDAL
- ❷ SOFT PEDAL
- ❸ AUX.OUT L/MONO
- ❹ AUX.OUT RIGHT
- ❺ PHONES
- ❻ MIDI IN
- ❼ MIDI OUT

The Connectors

Using the AC power jack

1. Connect the power cable to the AC power jack on the underside of the piano body.

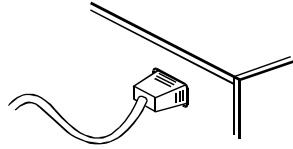

2. Ensure the piano is turned off when connecting and disconnecting the power.



3. Turn the volume switch anti-clockwise to reach the minimum volume level.

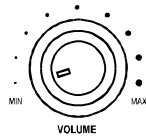

4. Plug the power cable into an AC power outlet.

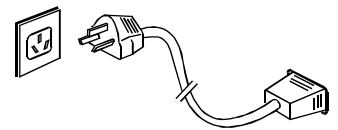

5. If you have done the above procedures, you are now safe to turn on the piano.

Caution: • When the piano is not in use or during a thunderstorm, disconnect the power for safety sake.

Using Headphones

An optional set of stereo headphones can be connected to the headphones jack located on the left panel of the piano body.

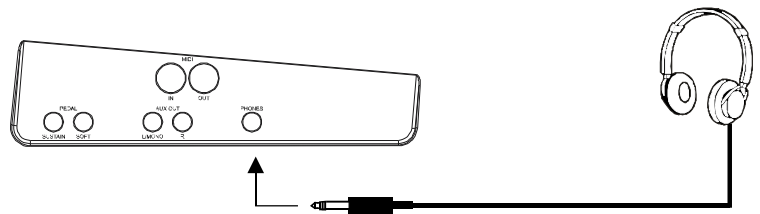

Caution: • Never use the headphone with high volume, as it may hurt your ear.

Using the AUX.OUT jack

When you want to listen to the voice with an amplifier, connect amplifiers to the AUX OUT L/MONO and R jacks on the left panel. The volume is adjusted with the VOLUME button. (For monaural playback, use the L/MONO jack. For stereo playback, connect both L/MONO and R jacks.)

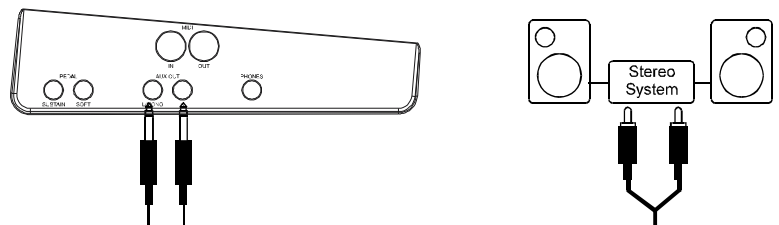

The Connectors

Using the Foot Pedals

An optional footswitch can be plugged into the SUSTAIN jack for sustain control. The footswitch function is like the sustain pedal on a piano. Press it for sustain.

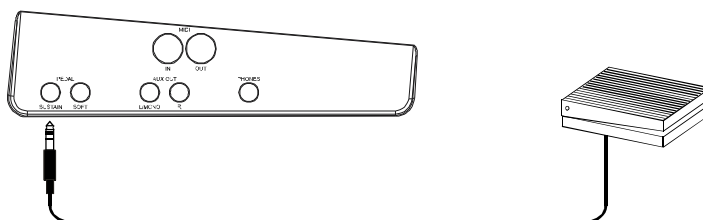

An optional footswitch can be plugged into the SOFT jack for soft control. The footswitch function is like the soft pedal on a piano. Press it for soft effect.

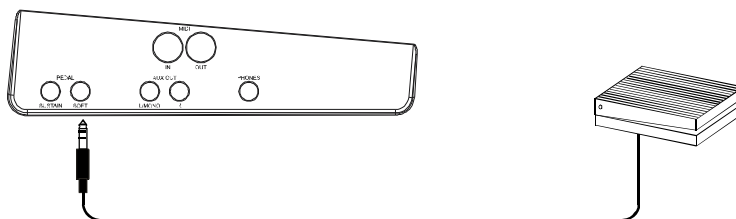

Using the MIDI IN/OUT Jack

MIDI stand for Musical Instrument Digital Interface. MIDI is a world wide standard that makes it possible for various electronic musical instruments and other devices.

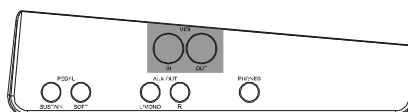

MIDI IN: Data transmitted from other MIDI instrument via MIDI is received by this terminal.

MIDI OUT: Data produced by the Digital Piano is transmitted to other MIDI instruments via MIDI from this terminal.

Operation

1. Power Switch & Volume

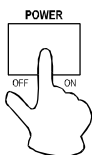

1. Turn the **POWER** to switch on the piano.
The LED display lightens up.

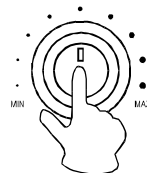

2. Use the volume control switch to adjust the volume to your desired level

- Caution:**
- If the LED display has not lightened up after you turned on the piano, please check the power supply.
 - If the piano is silent, the volume may be adjusted to its minimum level.
 - Although main power is OFF, the piano is not disconnected from the power supply completely!

2. Voice/Dual Voice

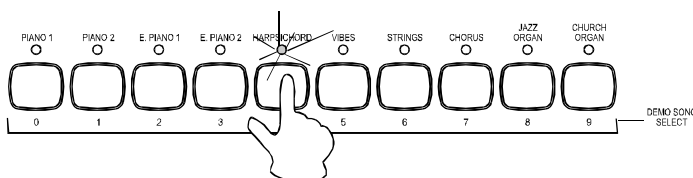
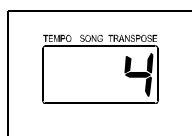

- Select a voice by pressing one of the [VOICE TYPE] button, the corresponding indicator will lighten up and the number of the selected voice will appear on the LED.

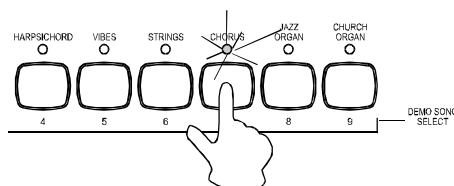
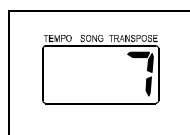

- Press the [DUAL] button to enter the Dual Voice mode, then select the second voice by pressing a [VOICE TYPE] button.
- To quit the Dual Voice mode, press the [DUAL] button again.
- While recording, Voice 2 will turn off automatically.

3. Metronome

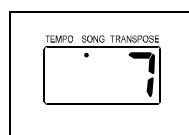
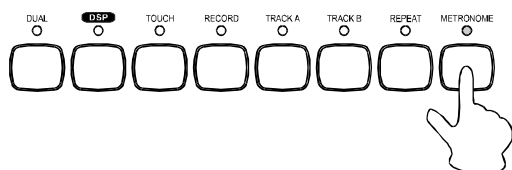

- Press the [METRONOME] button to turn on/off the metronome function.
- You cannot use the metronome function when the DEMO song is playing.
- To turn off the metronome, press the [STOP] button.

Operation

4. DSP (Digital Signal Processor)

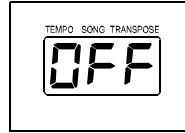
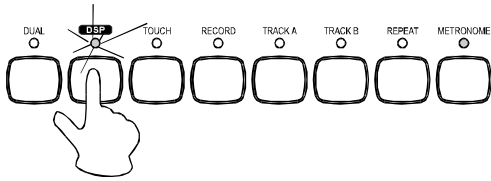

- Press the [DSP] button to turn on/off the DSP. The status will appear on the LED.

5. Transpose

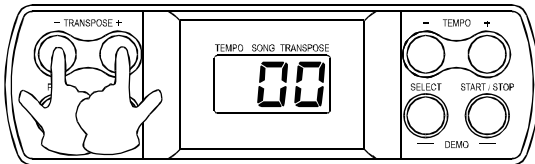
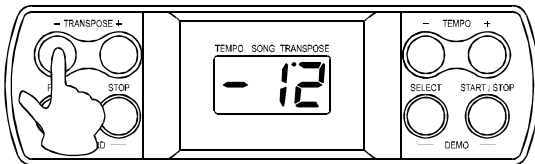

- The Transpose function allows you to change the pitch of the instrument in semi-tone steps, up to a maximum setting of 12 semitones above or below standard pitch.
- To restore the normal Transpose position, press both the +/- buttons simultaneously.

6. Tempo

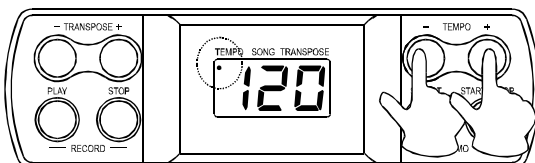
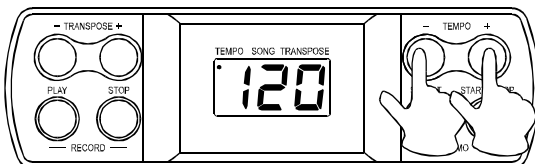
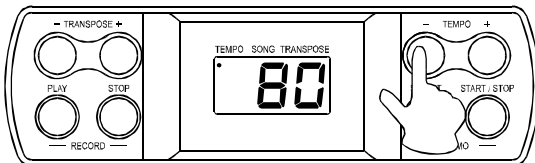

- You can speed up or slow down the tempo of a song or metronome by pressing the [TEMPO +/-] buttons.
- To restore the default tempo, press both the +/- buttons simultaneously. When you press both the +/- buttons when the song/metronome is stopping, the tempo will return to 120.
- When you are adjusting the tempo, the tempo indicator will appear on the display.

Operation

7. Touch Response

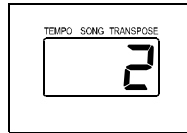
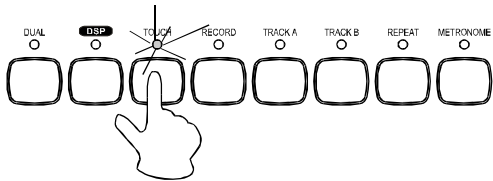

- There is touch response function and it is a default setting.
- Press the [TOUCH] button to adjust the touch response level in the range of 1 to 3. 2 is the default level.
- To turn off the touch response function, press the [TOUCH] button repeatedly until "OFF" appearing on the display.

8. Record & Playback

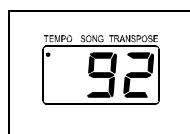
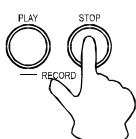
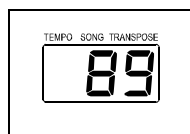
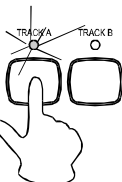
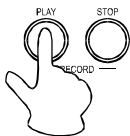
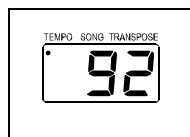
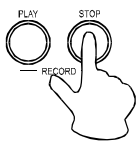
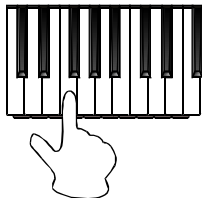
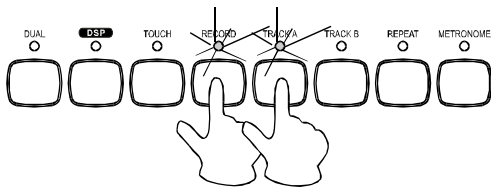

- **Record**
 - Press the [RECORD] button to record. The indicator of record lightens up.
 - There are 2 tracks for recording. They are track A and track B. Select and press the [TRACK A] or [TRACK B] button to save your recording.
 - To remove the recorded data and record again, press the [RECORD] and [TRACK A] or [TRACK B] simultaneously. Their indicators lighten up and flash.
 - Play a key on the keyboard to start recording.
 - To stop recording, press the [STOP] button.
- **Playback**
 - Select and press the track you want to playback. Its indicator will lighten.
 - Press the [RECORD-PLAY] button to start playing back the track.
 - To stop the playback, press the [RECORD - STOP] button .

Operation

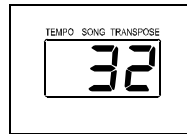
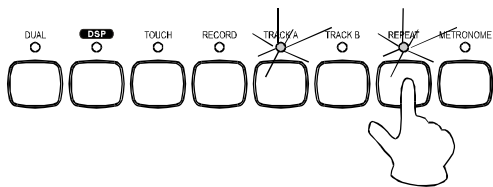

9. Demo Song

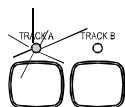
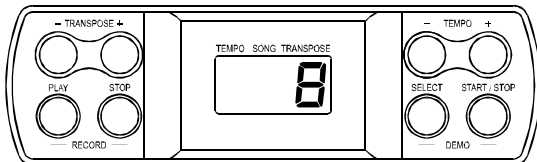
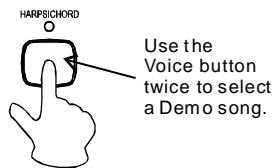
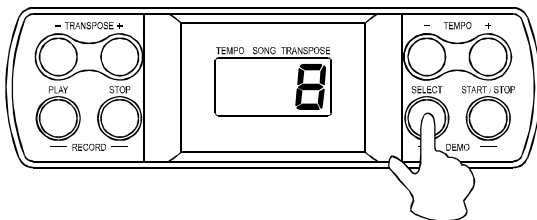

- **Repeat the playback**

During the playback, press the [REPEAT] button to set the point of beginning that you want to listen. "r-A" will appear on the display, then press the [REPEAT] button again to set the end point of the playback. "r-B" will appear on the display and the recorded song will playback repeatedly.

- **Select a Demo song**

- Hold the [SELECT] button.

- The number of the current demo song will appear on the display.

- Use the Voice Select buttons (0-9) to select your desired demo song. You must enter a 2-digit number (00-19).

- **Play the demo songs in sequence**

- Press the [DEMO ALL] button to start playing the demo songs in sequence. To stop the demo songs, press the [DEMO ALL] or [START/STOP] button.

- When the demo songs is playing, you can not change it to another one immediately.

- **Select a track of the demo song**

- While the demo song is playing, you can deactivate the corresponding track by pressing the [TRACK A] or [TRACK B] button.

- No sound to be played, if two tracks are deactivated.

- Press the track button again to play the demo song.

Operation

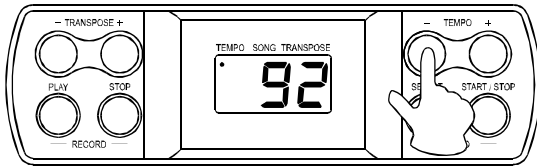
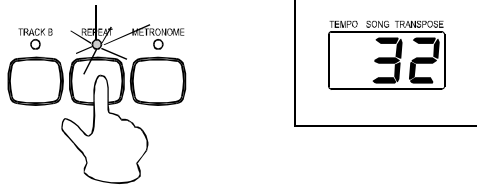

- **Repeat the demo song**
 - When a demo song is playing, press the [REPEAT] button to set the point of beginning that you want to listen. "r-A" will appear on the display, then press the [REPEAT] button again to set the end point of the playback. "r-B" will appear on the display and the selected section of the demo song will playback repeatedly.
 - This function does not work after pressing the [DEMO ALL] button and its songs are playing.
- **Adjust the tempo of demo song**

When a demo song is playing, you can adjust its tempo by pressing the [TEMPO +/-] buttons.

MIDI

The MIDI IN and MIDI OUT terminals, which is located at the rear panel of the unit. The following shows the description of MIDI and the steps of using MIDI function.

What is MIDI?

MIDI stand for Musical Instrument Digital Interface. MIDI is a world wide standard that makes it possible for various electronic musical instruments and other devices, such as computers, to "communicate with each other".

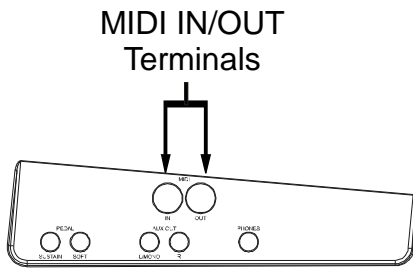

The keyboard is equipped with two types of MIDI terminals. they are located on the rear panel.

- **MIDI IN**
Data transmitted from other MIDI instruments via MIDI, is received at this terminal.
- **MIDI OUT**
Data produces by the keyboard, is transmitted to other MIDI instruments via MIDI from this terminal.

What you can do with MIDI?

- Record a data by using the Auto Accompaniment on an external sequencer .
After recording, you can edit the data with the sequencer, then play it again on the piano.

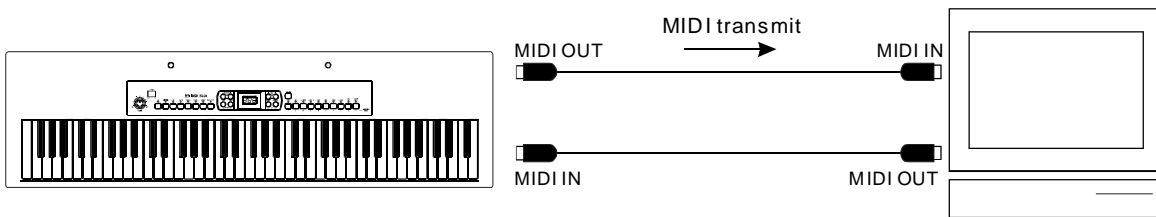

- Play music from another keyboard .

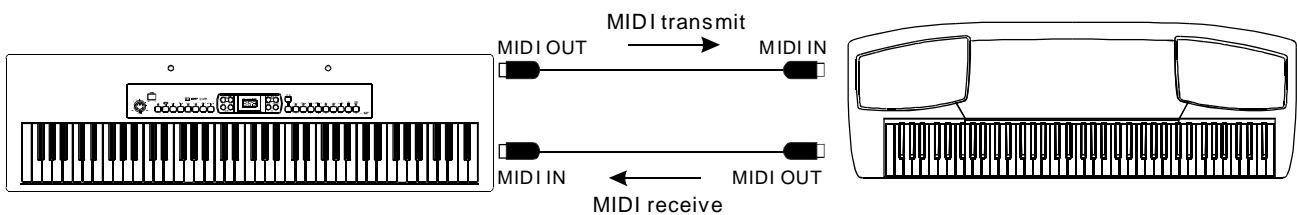

Specifications

Keyboard	88 hammer action keys
Voice	10 Voices
Demo Song	20 Demo Songs
Display	LED
Switch and Buttons	POWER SWITCH, VOLUME SWITCH, DUAL, DSP, TOUCH, RECORD, TRACK A, TRACK B, REPEAT, METRONOME, TRANSPOSE +/-, TEMPO +/-, DEMO ALL, RECORD - PLAY/STOP, DEMO - SELECT/ START/STOP, VOICE SELECT 0-9
Transpose	±12 semitones
Touch Response	Hard, Medium, Soft, Off
Connectors	AC POWER, HEADPHONES, AUX.OUT L/MONO, AUX.OUT R, MIDI IN/OUT, SUSTAIN PEDALS, SOFT PEDAL
Dimension	1360 x 345 x 138mm
Weight	20.5kg

Voice List

NO	NAME OF VOICE	NAME OF VOICE ON PANEL
0	ACOUSTIC GRAND PIANO	PIANO 1
1	BRIGHT ACOUSTIC PIANO	PIANO 2
2	E. PIANO 1	E. PIANO 1
3	E. PIANO 2	E. PIANO 2
4	HARPSICHORD	HARPS.
5	VIBRAPHONE	VIBES
6	STRINGS ENSEMBLE	STRINGS
7	CHORUS	CHORUS
8	JAZZ ORGAN	JAZZ ORGAN
9	CHURCH ORGAN	CHURCH ORGAN

Demo Song List

00	GIPSY RONDO
01	TOCCATA
02	MAPLE LEAF RAG
03	THE STING
04	MINUET 1
05	SPRING
06	VOICES OF SPRING
07	HALELUYA
08	BABY ELEPHANT WALK
09	WEDDING MARCH
10	ANDANTE [SURPRISE] SYMPHONY
11	TURKISH MARCH
12	SONATINA MOVEMENT
13	MINUET 2
14	THE LAST ROSE OF SUMMER
15	CLELITO LINDO
16	BEAUTIFUL DREAMER
17	WEBER'S LAST THOUGHT
18	JOY TO THE WORLD
19	TRINITY