

DIGITAL DRUM

Instruction Manual



Congratulations!

Thank you for purchasing this digital drum module. The drum module has been developed to act and play like a drum set but with greater ease. Before you use the instrument, we recommend you to read through this manual.

Taking Care of Your Digital Drum Set

Location

- Do not expose the unit to the following conditions to avoid deformation, discoloration, or more serious damage.
- Direct sunlight.
- High temperature (near a heat source, or in a car during the day time).
- Excessive humidity.

Power Supply

- Make sure to sure use the suitable AC adaptor, and also make sure the AC outlet voltage at your country matches the input voltage specified on the AC adaptor`s label.
- Turn the power switch OFF when the instrument is not in use.
- An AC adaptor should be unplugged from the AC outlet if the instrument is not be used for an extended period of time.
- Unplug the AC adaptor during electric storms.
- Avoid plugging the AC adaptor into the same AC outlet as appliance with high power consumption, such as electric heaters or ovens. Also avoid using multi-plug adaptors since these can result in reducing the sound quality, operation errors, and possibly damage.

Turn Power OFF When Making Connections

- To avoid damage to the instrument and other devices to which it is connected, turn the power switches of all related device OFF prior to connecting or disconnecting cables.

Handling and Transport

- Never apply excessive force to the controls, connectors or other parts of the instrument.
- Always unplug cables by gripping the plug firmly, but not pulling on the cable.
- Disconnect all cables before moving the instrument.
- Physical shocks caused by dropping, bumping, or placing heavy objects on the instrument can result in scratches and more serious damage.

Cleaning

- Clean the unit with a dry soft cloth.
- A slightly damp cloth may be used to remove stubborn grime and dirt.
- Never use cleaners such as alcohol or thinner.
- Avoid placing vinyl object on top of the unit (vinyl can stick to and discolor the surface).

Electrical Interference

- This instrument contains digital circuitry and may cause interference if placed too close to radio or television receivers. If this occurs, move the instrument further away from the affected equipment.

THIS DEVICE COMPLIES WITH PART 15 OF THE FCC RULES. OPERATION IS SUBJECT TO THE FOLLOWING TWO CONDITIONS:
(1) THIS DEVICE MAY NOT CAUSE HARMFUL INTERFERENCE, AND
(2) THIS DEVICE MUST ACCEPT ANY INTERFERENCE RECEIVED, INCLUDING INTERFERENCE THAT MAY CAUSE UNDESIRE OPERATION.

Contents

Panel Controls	4
- Front Panel	4
- Rear Panel	5
- Side Panel	5
Setup	6
- Connect the Pads and the Pedal	6
- Connect a MIDI device	7
- Connect a audio equipment	7
- Connect a CD player, etc.(Aux in jack)	7
- Connect Headphones	7
- Connect the Power supply jack	7
Functions	8
- Switch the power ON	8
- Set the main volume	8
- Select a drum kit	8
- Play with a Metronome	8
Play a Song	9
- Select a Song	9
- Listen to the Song	9
- Adjust the Song's volume	9
- Adjust the Song's tempo	9
- Tap tempo function	10
- Mute a Drum part	10
- Play with a Click voice	10
- Use the lighting guide function	10
Create a User Drum Kit	11
- Set a drum voice	11
- Adjust the volume of Pad	11
- Save your drum kit voices	11
Setting	12
- Adjust the pad sensitivity	12
- Set the rejection for each pad	12
- Reverb	13
- Tuning	13
- Factory set	13
Specifications	14
Voice list	15
Preset kit list	16
Song list	16
MIDI implementation chart	17

Panel Controls

Front Panel

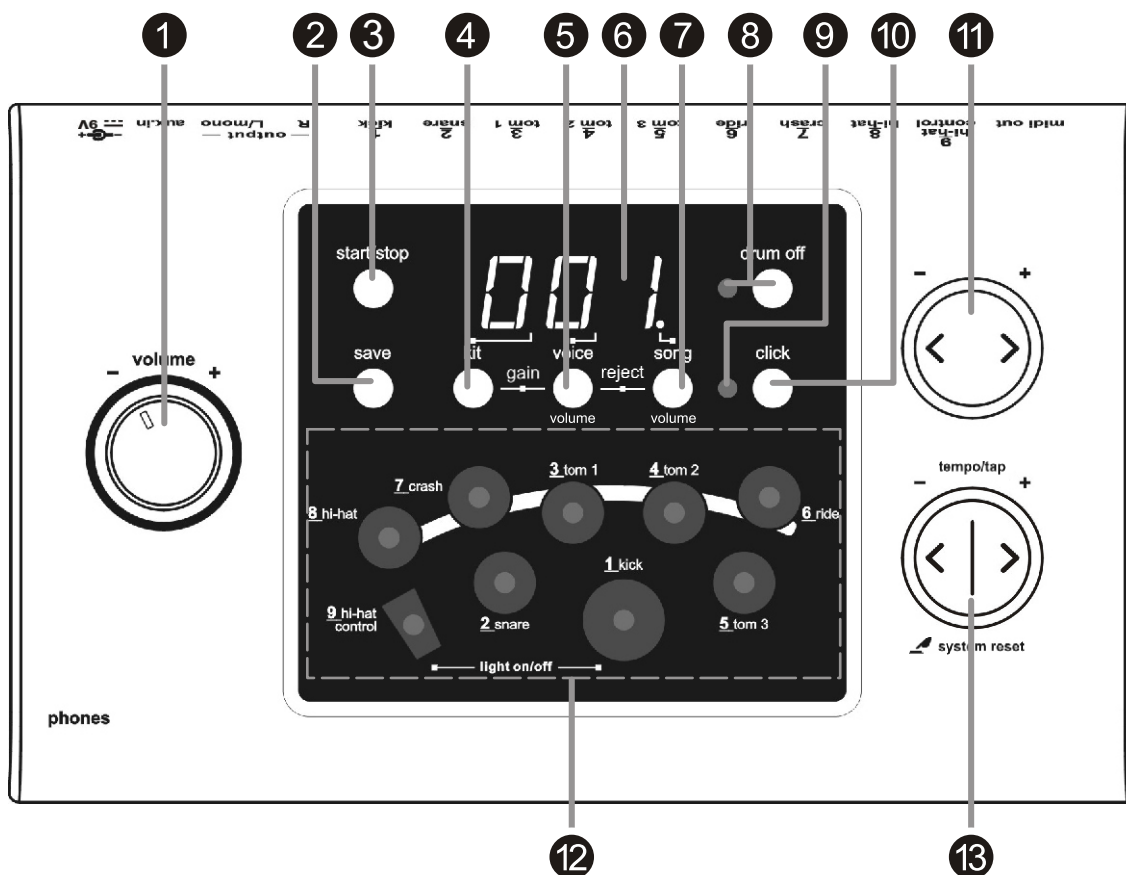

1 Volume knob

Control the volume of phone and line output. Turn it clockwise to increase the volume and anticlockwise to decrease it.

2 [save] button

Save current kit setting to a user kit.

3 [start/stop] button

Start or stop song playing.

4 [kit] button

Display the drum kit number or reverb setting.

5 [voice / volume] button

Display the voice number, volume value or pitch value.

6 3-digit LED display

Display the parameters of current menu mode.

7 [song / volume] button

Display the song number or accompaniment volume value.

8 [drum off] button and indicator

This button is used to turn on or turn off the percussion of song.

9 Beat indicator

Beat of metronome or a song is playing

10 [click] button

Turn on or off the metronome.

11 [+] and [-] buttons

These buttons are used to change the setting number of kit, voice, song and adjust the Pad volume.

12 Pad select buttons and indicators

Select current pad and adjust the pad volume. When you press them, the corresponding indicator lights up.

13 [tempo - / +] and [tap] buttons

Change current tempo.

Rear Panel

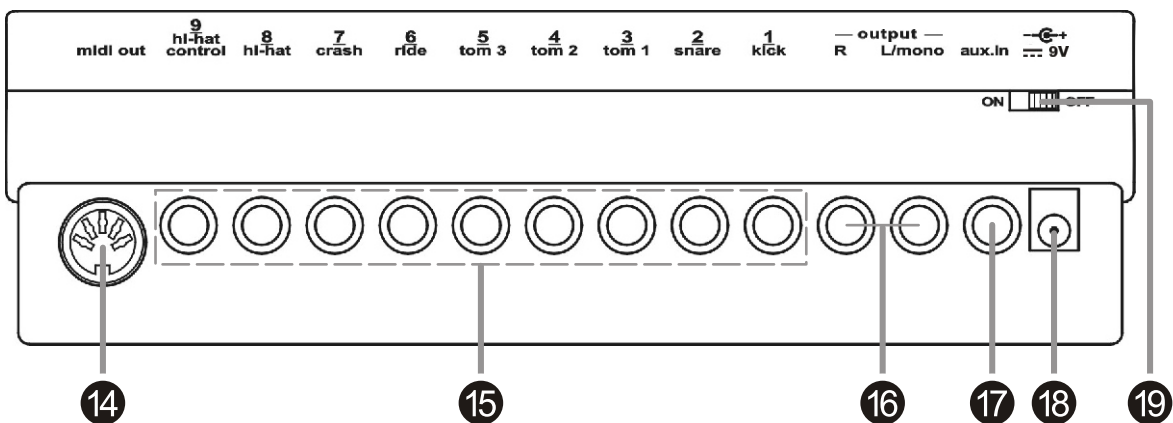

14 MIDI out jack

Connect with external sound module.

15 Trigger input jacks

Connect with pads, cymbals, hi-hat control, kick trigger.

16 Output jacks (R, L/mono)

Connect with the amplifier or audio system.
For monaural output use the L/mono jack.

17 Aux.in jack

Connect with external sound source.

18 Power supply jack (DC in 9V)

Connect an AC adaptor to this jack.

19 Power switch

Turn the power on/off.

Side Panel

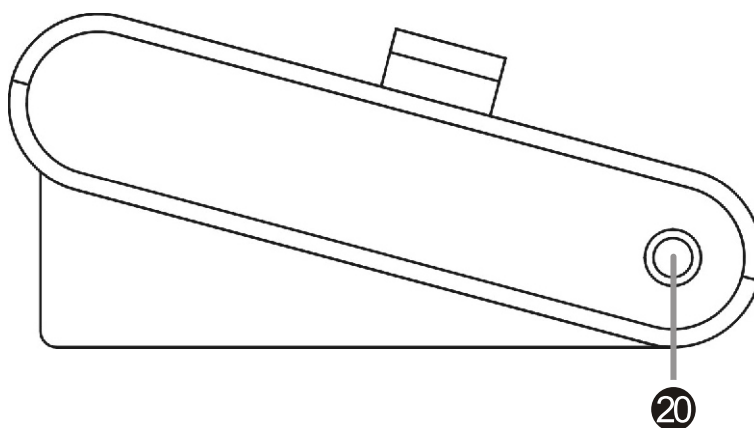

20 Phones jack

Connect with to a pair of stereo headphones to this jack.
(Connect the headphones will not mute the output jacks.)

Setup

Caution!

To prevent electric shock and damage to the device, make sure the power is switched OFF on the drum and all related device before making any connection.

Connect the Pads and the Pedals

Using the provided cables, connect each Trigger input jack on the rear panel of the module, and make sure each pad is connected to its corresponding Trigger input jack.

Note:

1. The voice of hi-hat pad hitting is controlled by hi-hat pedal. Similar to a real drum kit, the hi-hat pad functions as an 'open hi-hat' when the pedal is stepped. When the pedal is released, it functions as a 'closed hi-hat'.
2. The valid striking area of a cymbal pad (ride, crash or hi-hat) is near the edge of the pad, which is different from other pads.

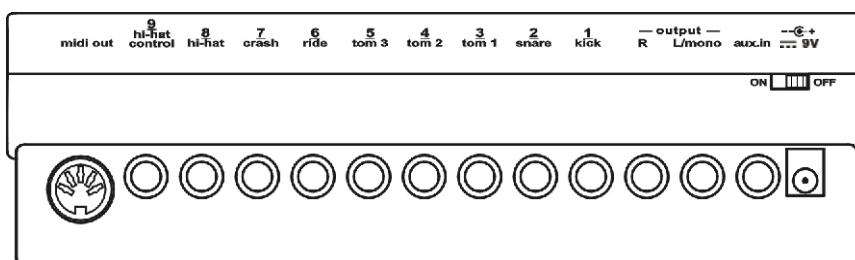
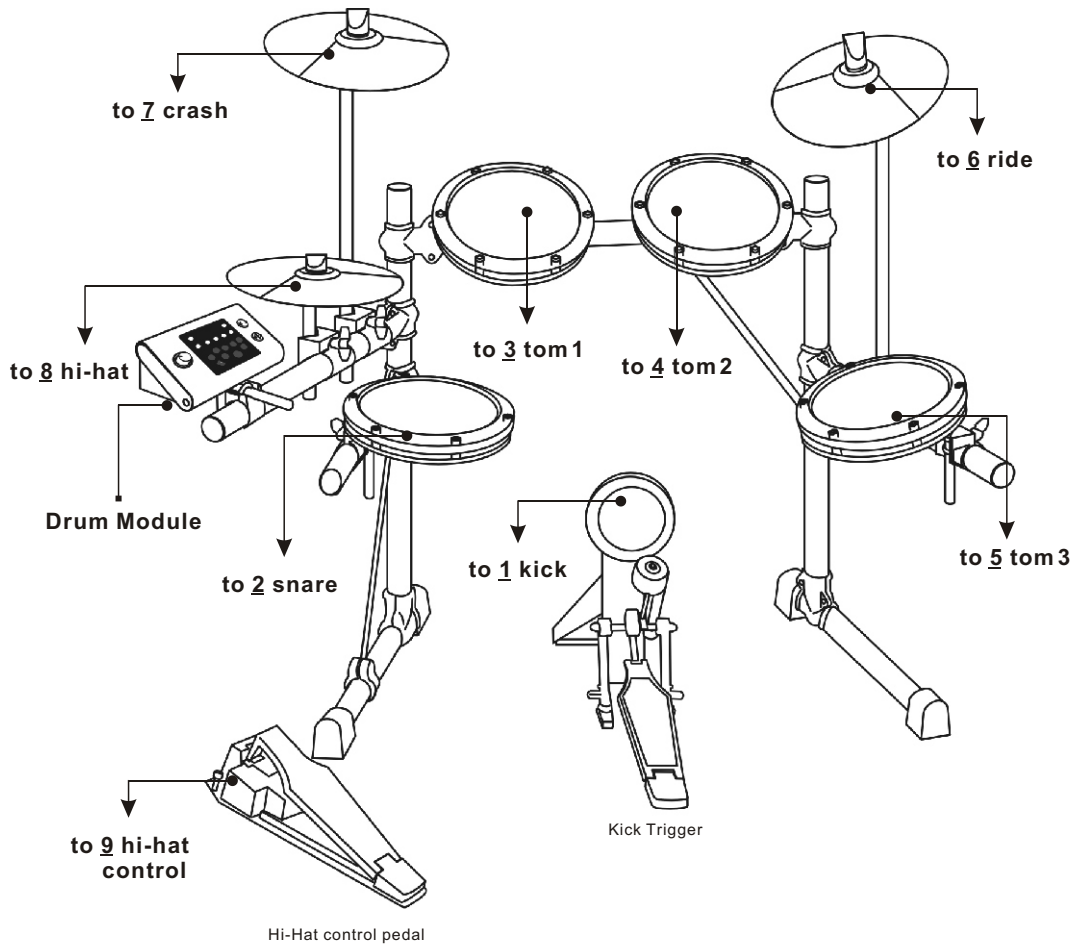

Connect a MIDI device

This is for you want to use an external sound module or MIDI sequencer.

Transmit MIDI Data

1. Use a MIDI cable to connect the MIDI OUT jack on the drum module with the MIDI IN jack on the external MIDI device.
2. This drum will output all the MIDI codes generated by pads hitting or pedal stepping via the MIDI output connector. But clicking and the MIDI codes in songs are excluded.

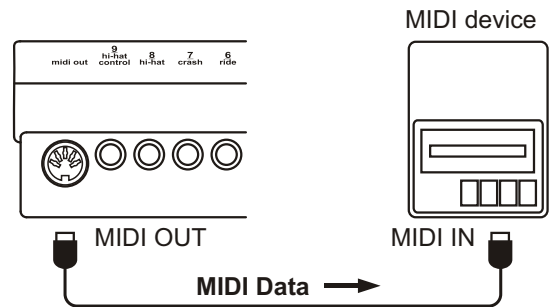

Connect a audio equipment

1. When you want to listen to the voices with an amplifier, connect amplifiers with the Output L/MONO and R jacks on the rear panel. (For monaural playback, use the L/MONO jack; for stereo playback, connect both L/MONO and R jacks.)
2. The volume is adjusted with the VOLUME knob.

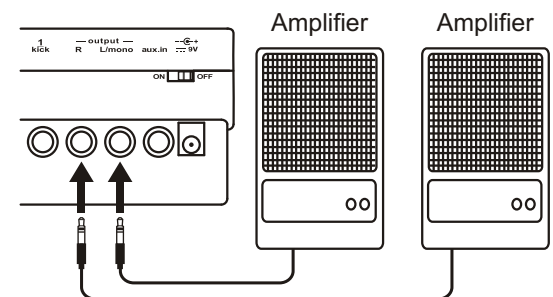

Connect a CD player, etc.(Aux. In jack)

1. The audio output of a CD player, or other audio source, to connect with the AUX IN jack on the rear panel can be mixed with the sound of the drum. This function is convenient that lets you play along with a favourite song.
2. The volume of the external signal is adjusted with the VOLUME knob.

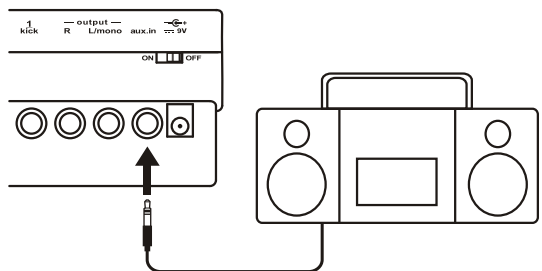

Connect Headphones

An optional set of stereo headphones can be connected with the PHONES jack located on the side of the drum module.

- * Adjust the volume to a comfortable level.

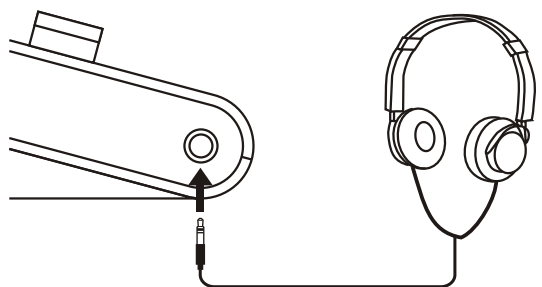

Connect the Power supply jack

Make sure the power is switched OFF and connect the power adaptor with the DC IN jack on the rear panel.

Note:

1. To protect the speakers, amplifier and the drum module from damage, rotate the volume knob to the minimum volume level before switching the power ON.
2. Make sure the power is switched OFF when connecting drum module with external devices.

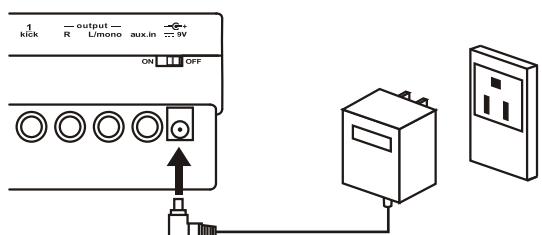

Functions

Switch the power ON

After confirming all connection have been completed, rotate the volume knob to the left (minimum volume level) before switching the power on.

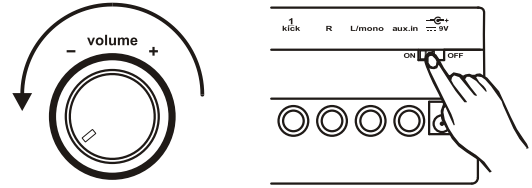

Set the power switch to "on" position to switch on the power. Display shows the song's number and its indicator lights up.



Set the main volume

While hitting a pad, gradually rotate the volume knob until a comfortable volume level is reached.

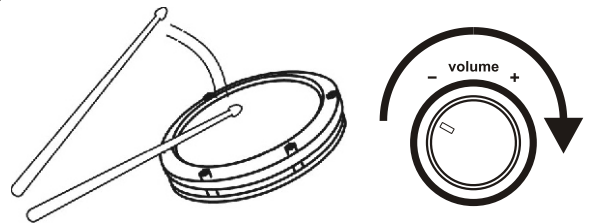

Select a drum kit

The unit comes with 20 (001-020) preset drum kits and 10 user kits (021-030). (Reference song list : page 15.)

1. Press [kit] button
The current kit number appears and the Kit indicator lights.
2. Press [+] or [-] buttons to select the drum kit number (001 - 020) you want to use.

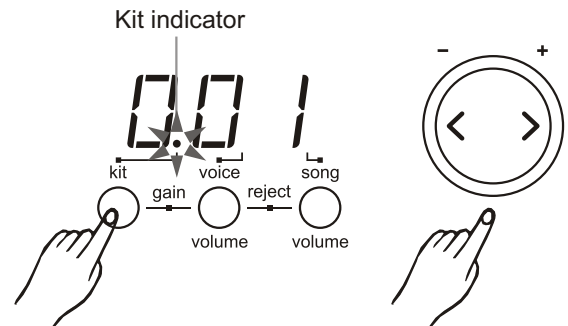

Play with a Metronome

1. Press the [click] button to start the metronome. The beat indicator is flashing and the click sound begins to play.
2. Press the [tempo +] or [tempo -] buttons to set the metronome beat.
3. Press the [click] button again to stop the metronome.

Adjust the volume of the click sound

Hold down the [click] button and press the [+] or [-] buttons to adjust the volume of the click sound, the metronome automatically play.

*When playing the metronome:

The metronome stops immediately when holding down [click] button, and pressing the [+] or [-] buttons on the click sound.

*Volume of the click sound will be reset to default once power is on.

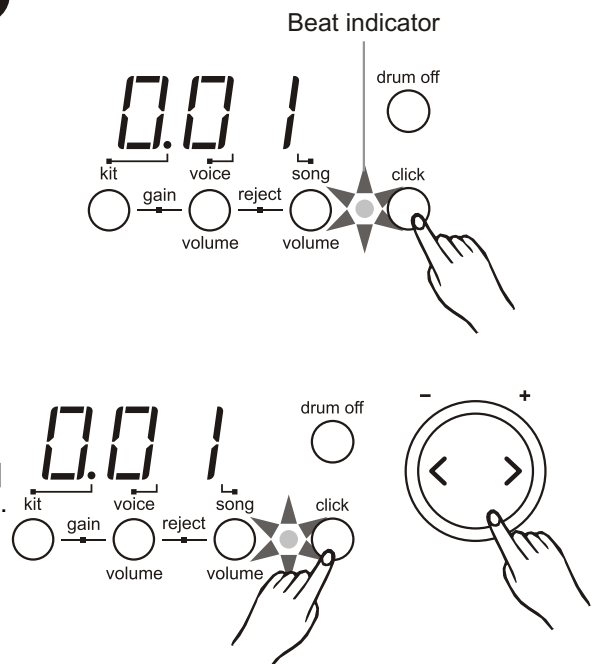

Play a Song

Select a song

This drum module has a total of 50 preset songs.

Note: The preset song setting is 001 after you slide on power.

1. Press [song / volume] button.
The song indicator lights and the current song's number appears.
2. Press [+] or [-] buttons to select one of the song and listen to it.
Song numbers 001 - 050 are preset songs.
(Reference song list : page 16.)

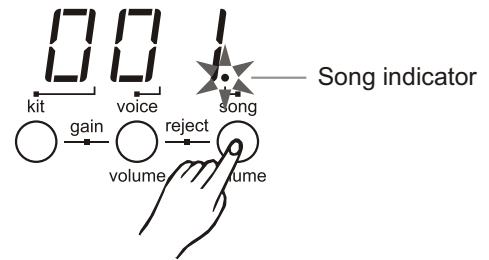

Listen to the song

1. Press [start/stop] button and the beat indicator is flashing.
After the counting, the song will start playback from the beginning.
2. The song will stop when it reaches the end.
You can stop the song during playback by pressing the [start/stop] button.

* The ASSIGN pad's indicator flashes at the first beat of each measure.

Note: The ASSIGN pad's indicator can be lighted off by pressing both [hi-hat] and [kick] buttons at the same time.

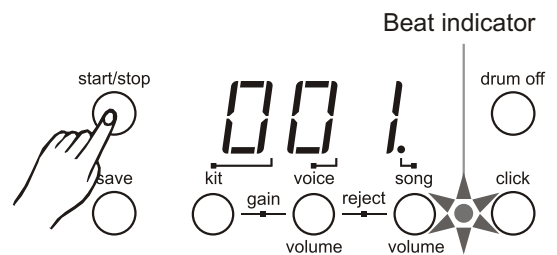

Adjust the song's volume

1. Press the [song / volume] button to select the volume of song. Display shows : "A XX".
(XX = level value, 00 to 31)
2. Press [+] or [-] buttons to adjust the volume of song accompaniment.

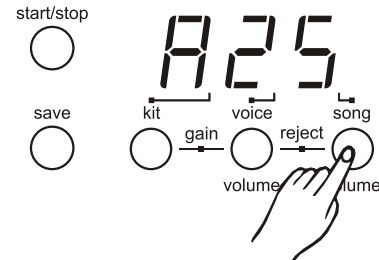

Adjust the song's tempo

1. Press the [tempo +] or [tempo -] buttons. Display shows the current tempo value.
 2. Press the [tempo +] or [tempo -] buttons to increase or decrease the tempo. (tempo value in the range of 30 to 280)
- * Holding down either a [tempo +] or [tempo -] buttons to change the setting in a high speed.
* Press [tempo +] and [tempo -] buttons at the same time to reset the tempo to default value.

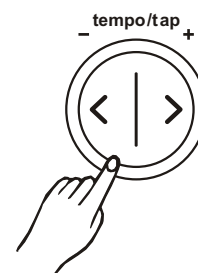

Note: About 2 seconds after you stop pressing the [Tempo] button, display changes to show your selected song, voice or kit number instead of tempo value.

Tap tempo function

This function allows you to set the song's tempo by tapping in tempo on a pad.

1. Press the [tempo/tap] button. Display shows the current tempo value.
 2. Tap on the pad in the tempo that you want to get. Tap on the pad 4 times. The last two beats are only detected and are set as your desired speed.
 3. The song will be played with your desired tempo you set. When the song is playing, you are not allowed to change the tempo with this tempo function.
- * Any pads can do the tap tempo function.
 - * If there is no invalid operation, display will quit to the previous menu after 2 seconds.

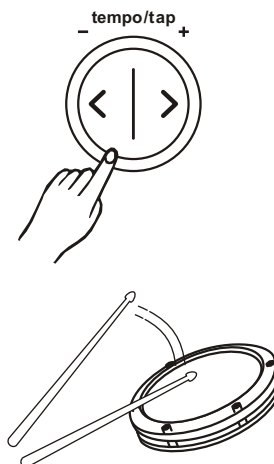

Mute a Drum part

1. Press [drum off] button. The drum off indicator lights. The drum mute function is active.
 2. Press [start/stop] button to playback the song. The drum part in the song will be muted.
 3. To cancel the drum mute function, press [drum off] button again. The drum off indicator light goes off.
- * The drum mute function can be used during song playing.

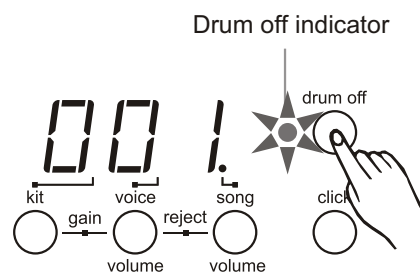

Play with a the Click voice

1. Press the [click] button to start the metronome. It will be played with tempo.
2. Press the [click] button again to stop the metronome.

Note: The click voice will not stop automatically once the song finished until you press the [click] button.

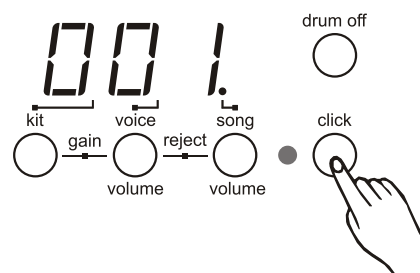

Use the lighting guide function

The lighting guide function provides you a valuable lesson to practice or learn the drum kit with playing the preset song.

1. Select the song number you want to practice.
 2. Press [drum off] button.
 3. Press [start/stop] button to start song play.
 4. Strike the pad in accordance with the lighting of pad's indicators or press the hi-hat pedal and kick the bass drum pad exactly when their indicators light.
- * During song playing, you can change the Tempo(speed), or use the tap tempo function to set your desired tempo.

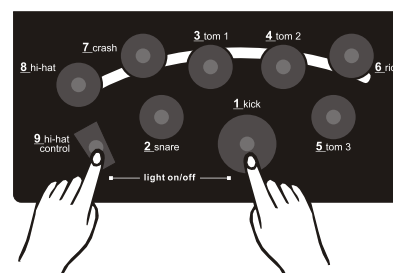

- * Press the [hi-hat control] + [kick] buttons to turn off all the pad's indicator. Press the [hi-hat control] + [kick] buttons again to turn on all the pad's indicator.

Create a User Drum Kit

Set a drum voice

The unit comes with 215 high quality percussion sounds that you can assign to any of the drum pad, 3 cymbals, hi-hat control and bass drum. This way you can create your own drum kit that consists of the voice you want. (Reference voice list : page 15.) The kit number 021-030 is use for saving your own drum kit.

1. Press [voice] button.
The voice indicator lights and the display shows the voice number of this pad.
2. Press [pad] button or hit the pad you want to set. The pad indicator light and display shows the current voice number of lighting pad.
3. Press [+] or [-] buttons to select the voice number you want to assign.
4. Repeat step 2 and 3 for to set the voice for another pad or bass drum.

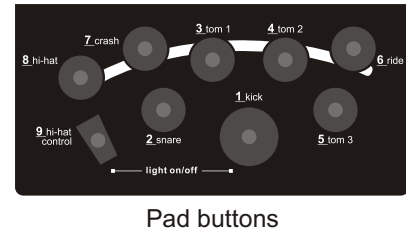

Adjust the volume of Pad

This unit allows you to adjust the volume of every voices in the kit that let you control the individual level (volume) of the pads or bass drum.

1. Press the [voice / volume] button to select the volume level setting display shows : " L XX". (XX = level value, 00 to 31)
The pad button indicator lights and display shows the current volume level of lighting pad.
2. Press the [PAD] button or kit the percussion pad you want to adjust.
3. Press the [+] or [-] buttons to increase or decrease the volume. While you are adjusting, hit the corresponding pad and listen carefully the sound level until reaching the level you want.
4. Repeat step 2 and 3 to adjust the volume of other pad voices.

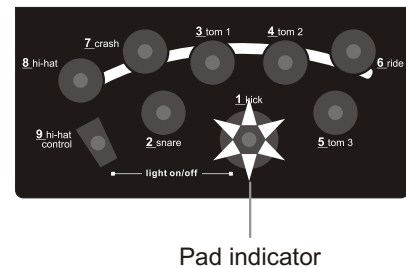
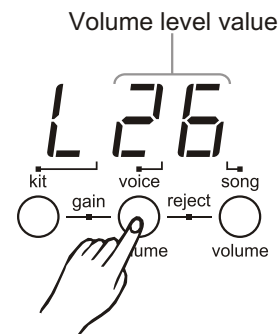

Save your drum kit voices

Once completing to your own drum kit, you have to save them in the unit; otherwise your drum kit will be erased when you turn off the unit.

1. Press [save] button.
The kit number 021 appears and is flashing.
2. Press [+] or [-] buttons to set the kit number (021-030) for saving your drum kit.
3. Press [save] button again. The flashing kit number stops.

Note: To cancel the save operation, press the [voice] button. If there is a fault, the display will show "Err".

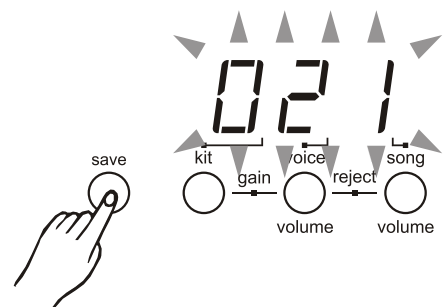

Setting

Adjust the pad Sensitivity

You can adjust the sensitivity(gain) of the inputs from pads.

1. Hold down [kit] and press [voice / volume] buttons.
Display shows: "EXX", the pad sensitivity value is indicated.
(XX=gain level value, 00 to 15.)
2. Press [pad] button or hit the pad you want to set.
The pad indicator light .
3. Press [+] or [-] buttons to adjust the sensitivity of pads.
Range : 00-15
Large values will produce a high sensitivity even if the pad is hit softly.
Lower values will producing a low sensitivity even if the pad is hit forcefully.
4. Repeat step 2 and 3 for to set the voice for another pad or bass drum.

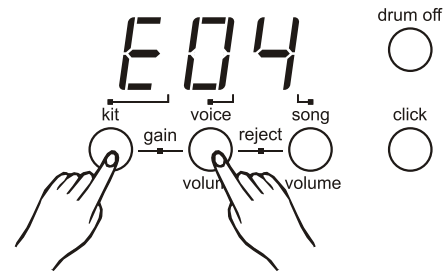

Note:

1. After adjusting the sensitivity value, you can save them into built-in memory. In the sensitivity mode, the sevstivity value is displayed, press [save] button and then return to previous display.
2. The drum remains untouched for 10 seconds, the LED will return to previous display.
3. If turn off the power without save, you will lose the changes you have just made.

Set the rejection for each pad

Prevents crosstalk caused by pads or drums connected to other inputs. Events triggered by other pads that are of a lower input value than what is set here will not be delivered for a set lenght of time.

1. Hold down [voice / volume] and press [song / volume] buttons.
Display shows: "JXX", the rejection value is indicated.
(XX=rejection level value, 00 to 15.)
2. Press [pad] button or hit the pad you want to set.
The pad indicator light .
3. Press [+] or [-] buttons to adjust the sensitivity of pads.
Range : 00(no rejection)-15
4. Repeat step 2 and 3 for to set the voice for another pad or bass drum.

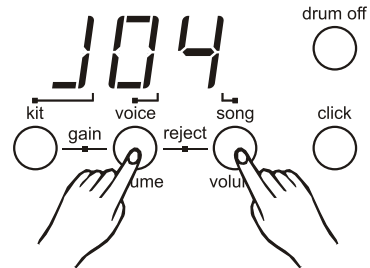

Note:

1. After adjusting the rejection value, you can save them into built-in memory. In the rejection mode, the rejection value is displayed, press [save] button and then return to previous display.
2. The drum remains untouched for 10 seconds, the LED will return to previous display.
3. If turn off the power without save, you will lose the changes you have just made.

Reverb

This function sets the reverb effect of the drum.

1. In " kit mode", press the [kit] button, display shows the current reverb setting.
2. Press [+] or [-] buttons to turn on or turn off the reverb.

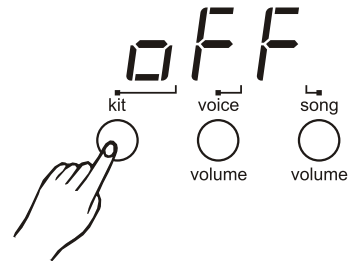
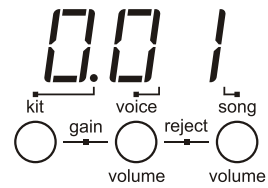

Tuning

This function sets the pitch of each drum pad voice.

1. Press the [voice / volume] button to select the pitch setting display shows : " P XX". (XX = value, 00 to 15)
The pad button indicator lights and display shows the current pitch setting of lighting pad.
2. Press the [PAD] button or kit the percussion pad you want to adjust.
3. Press the [+] or [-] buttons to set the pitch you want.
4. Repeat step 2 and 3 to set the pitch of other pad voice.

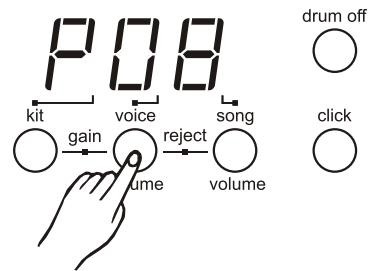

Factory reset

This drum module will reset its to initial settings.
Beware all the data will be lost.

1. Turn the power off.
2. Turn on the power while holding the [tempo -] and [tempo +] buttons.

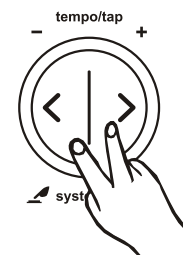

Specifications

Drum Pad:	4 drum pads , 3 cymbal pads , 1 hi-hat control pedal , 1 kick trigger
Voices:	215 voices
Drum kits:	20 preset kits, 10 user kits
Song:	50 preset songs
Controls:	POWER SWITCH, START/STOP, SAVE, KIT, VOICE/VOLUME, SONG/VOLUME, DRUM OFF, CLICK, HI-HAT, CRASH, RIDE, HI-HAT CONTROL, SNARE, TOM 1, TOM 2, TOM3, KICK, VOLUME, + / -, TEMPO + / -, TAP
Display:	LED display
Connections:	MIDI OUT Hi-hat control Hi-hat Crash Ride Snare Tom 1 Tom 2 Tom 3 Kick Output (R & L/MONO) Aux in
Power Supply:	AC adaptor (≡ 9V)

Drum Kit List

No.	Name	No.	Name
001	Standard 1	011	Latin 2
002	Standard 2	012	Percussion 1
003	Room 1	013	Percussion 2
004	Room Stick	014	Dance 1
005	Rhythm & Blues	015	Dance Stick
006	Jazz	016	Orchestra
007	Jazz Latin	017	Jungle
008	Brush	018	Electric
009	Brush 2	019	China Luogu
010	Latin 1	020	Oriental
.....			
021	User 1 (Electronic 5)	026	User 6 (Jazz latin)
022	User 2(Percussion 1)	027	User 7 (Room 1)
023	User 3 (Standard 1)	028	User 8 (Electric)
024	User 4 (Standard 2)	029	User 9 (Brush)
025	User 5 (Dance 1)	030	User 10 (Room stick)

Song List

No.	Name	No.	Name
001	Guitar Funk	026	Reggae
002	Fusion 1	027	Shuffle
003	Folk Pop	028	R & B 1
004	Rock 1	029	Rock N'Roll 1
005	Blues	030	8Beat 1
006	Newage	031	8Beat 2
007	Organ Funk	032	16Beat
008	Drum & Bass	033	March
009	Pop 8 Beat	034	Bossanova
010	Dance	035	Funk 1
011	Slow Rock 1	036	Fusion 2
012	Pop 1	037	Rock N'Roll 2
013	Rock Pop 1	038	Hard Rock
014	Jazz Ballad 1	039	Rock Pop 3
015	6/8 R & B	040	Funk 2
016	Pop 2	041	Funk 3
017	Jazz Ballad 2	042	Jazz
018	Ballad 1	043	Disco
019	Ballad 2	044	House
020	Ballad 3	045	Mambo
021	Waltz	046	R & B 2
022	Slow Rock 2	047	R & B 3
023	Rock Pop 2	048	Pop Dance
024	Salsa	049	Jing Opera
025	Beguine	050	Chinese Rhythm

MIDI Implementation Chart

	Function...	Transmitted	Remarks
Basic	Default	10 ch	
Channel	Changed	X	
Mode	Default	X	
	Messages	X	
	Altered	*****	
Note		0 - 127	
Number:	True voice	*****	
Velocity	Note on	O 9nH, V= 1 - 127	
	Note off	X (9nH. V= 0)	
After	Key's	X	
Touch	Channel's	X	
Pitch Bend		X	
Control	0	X	Bank Select
Change	1	X	Modulation
	5	X	Portamento Time
	6	X	Data Entry
	7	X	Volume
	10	X	Pan
	11	X	Expression
	64	X	Sustain Pedal
	65	X	Portamento ON/OFF
	66	X	Sostenuto Pedal
	67	X	Soft Pedal
	80	X	Reverb Program
	81	X	Chorus Program
	91	X	Reverb Level
	93	X	Chorus Level
	120	X	All Sound OFF
	121	X	Reset All Controller
	123	X	All Notes OFF
Program		X	
Change:	True #	X	
System	Exclusive	X	
System	: Song Position	X	
Common	: Song Select	X	
	: Tune	X	
System	: Clock	X	
Real Time	: Commands	X	
Aux	: Local ON/OFF	X	
	: All Notes OFF	X	
Messages	: Active Sense	X	
	: Reset	X	

O : YES

X : NO

