

DIGITAL DRUM

Instruction Manual



Congratulations!

Thank you for purchasing this digital drum module. The drum module has been developed to act and play like a drum set but with greater ease. Before you use the instrument, we recommend you to read through this manual.

Taking Care of Your Digital Drum Set

Location

- Do not expose the unit to the following conditions to avoid deformation, discoloration, or more serious damage.
- Direct sunlight.
- High temperature (near a heat source, or in a car during the day time).
- Excessive humidity.

Power Supply

- Make sure to use the suitable AC adaptor, and also make sure the AC outlet voltage at your country matches the input voltage specified on the AC adaptor's label.
- Turn the power switch OFF when the instrument is not in use.
- An AC adaptor should be unplugged from the AC outlet if the instrument is not be used for an extended period of time.
- Unplug the AC adaptor during electric storms.
- Avoid plugging the AC adaptor into the same AC outlet as appliance with high power consumption, such as electric heaters or ovens. Also avoid using multi-plug adaptors since these can result in reducing the sound quality, operation errors, and possibly damage.

Turn Power OFF When Making Connections

- To avoid damage to the instrument and other devices to which it is connected, turn the power switches of all related device OFF prior to connecting or disconnecting cables.

Handling and Transport

- Never apply excessive force to the controls, connectors or other parts of the instrument.
- Always unplug cables by gripping the plug firmly, but not pulling on the cable.
- Disconnect all cables before moving the instrument.
- Physical shocks caused by dropping, bumping, or placing heavy objects on the instrument can result in scratches and more serious damage.

Cleaning

- Clean the unit with a dry soft cloth.
- A slightly damp cloth may be used to remove stubborn grime and dirt.
- Never use cleaners such as alcohol or thinner.
- Avoid placing vinyl object on top of the unit (vinyl can stick to and discolor the surface).

Electrical Interference

- This instrument contains digital circuitry and may cause interference if placed too close to radio or television receivers. If this occurs, move the instrument further away from the affected equipment.

Contents

Panel Controls	4
- Front Panel	4
- Rear Panel	5
- Side Panel	5
Setup	6
- Connect the Pads and the Pedal	6
- Connect a MIDI device	7
- Connect a audio equipment	7
- Connect a CD player, etc.(Aux in jack)	7
- Connect Headphones	7
- Connect the Power supply jack	7
Functions	8
- Switch the power ON	8
- Set the main volume	8
- Select a drum kit	8
- Play with a Metronome	8
Play a Song	9
- Select a Song	9
- Listen to the Song	9
- Adjust the Song's volume	9
- Adjust the Song's tempo	9
- Tap tempo function	10
- Mute a Drum part	10
- Play with the Click voice	10
- Use the lighting guide function	10
Create a User Drum Kit	11
- Set a drum voice	11
- Adjust the volume of Pad	11
- Save your drum kit voices	11
Specifications	12
Voice list	13
Preset kit list	14
Song list	14
MIDI implementation chart	15

Panel Controls

Front Panel

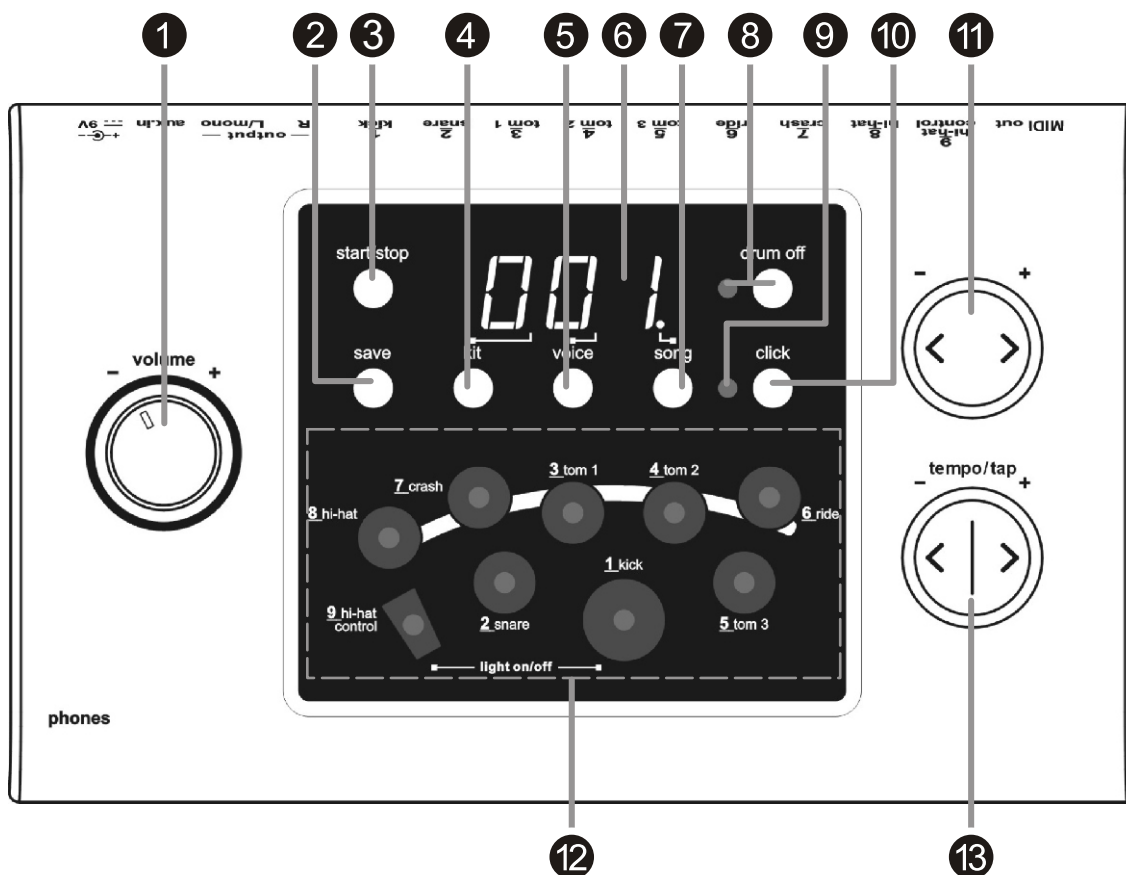

- 1 Volume knob**
Control the volume of phone and line output. Turn it clockwise to increase the volume and anticlockwise to decrease it.
- 2 [save] button**
Save current kit setting to a user kit.
- 3 [start/stop] button**
Start or stop song playing.
- 4 [kit] button**
Display the drum kit number.
- 5 [voice / volume] button**
Display the voice number or volume value.
- 6 3-digit LED display**
Display the parameters of current menu mode.
- 7 [song / volume] button**
Display the song number or accompaniment volume value.
- 8 [drum off] button and indicator**
This button is used to turn on or turn off the percussion of song.
- 9 Beat indicator**
Beat of metronome or a song is playing
- 10 [click] button**
Turn on or off the metronome.
- 11 [+] and [-] buttons**
These buttons are used to change the setting number of kit, voice, song and adjust the Pad volume.
- 12 Pad select buttons and indicators**
Select current pad and adjust the pad volume. When you press them, the corresponding indicator lights up.
- 13 [tempo - / +] and [tap] buttons**
Change current tempo.

Rear Panel

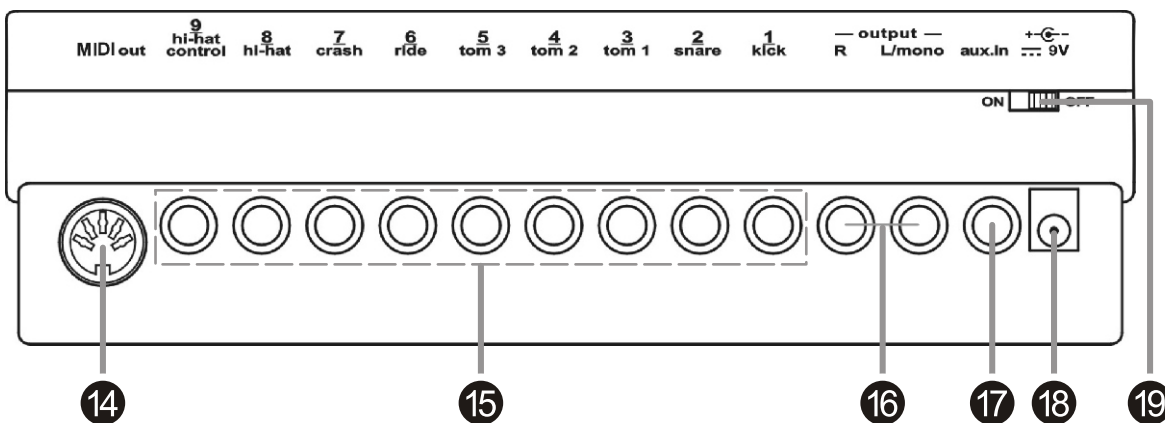

14 MIDI out jack

Connect with external sound module.

15 Trigger input jacks

Connect with pads, cymbals, hi-hat control, kick trigger.

16 Output jacks (R, L/mono)

Connect with the amplifier or audio system.
For monaural output use the L/mono jack.

17 Aux.in jack

Connect with external sound source.

18 Power supply jack (DC in 9V)

Connect an AC adaptor to this jack.

19 Power switch

Turn the power on/off.

Side Panel

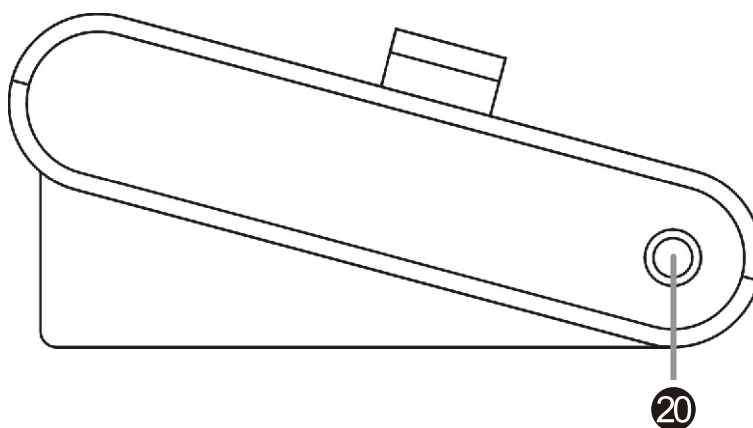

20 Phones jack

Connect with to a pair of stereo headphones to this jack.
(Connect the headphones will not mute the output jacks.)

Setup

Caution!

To prevent electric shock and damage to the device, make sure the power is switched OFF on the drum and all related device before making any connection.

Connect the Pads and the Pedals

Using the provided cables, connect each Trigger input jack on the rear panel of the module, and make sure each pad is connected to its corresponding Trigger input jack.

Note:

1. The voice of hi-hat pad hitting is controlled by hi-hat pedal. Similar to a real drum kit, the hi-hat pad functions as an 'open hi-hat' when the pedal is stepped. When the pedal is released, it functions as a 'closed hi-hat'.
2. The valid striking area of a cymbal pad (ride, crash or hi-hat) is near the edge of the pad, which is different from other pads.

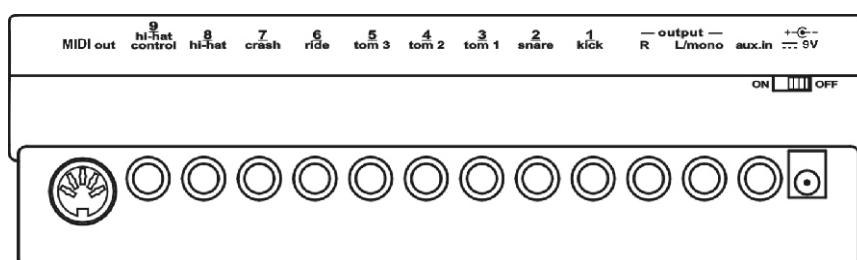
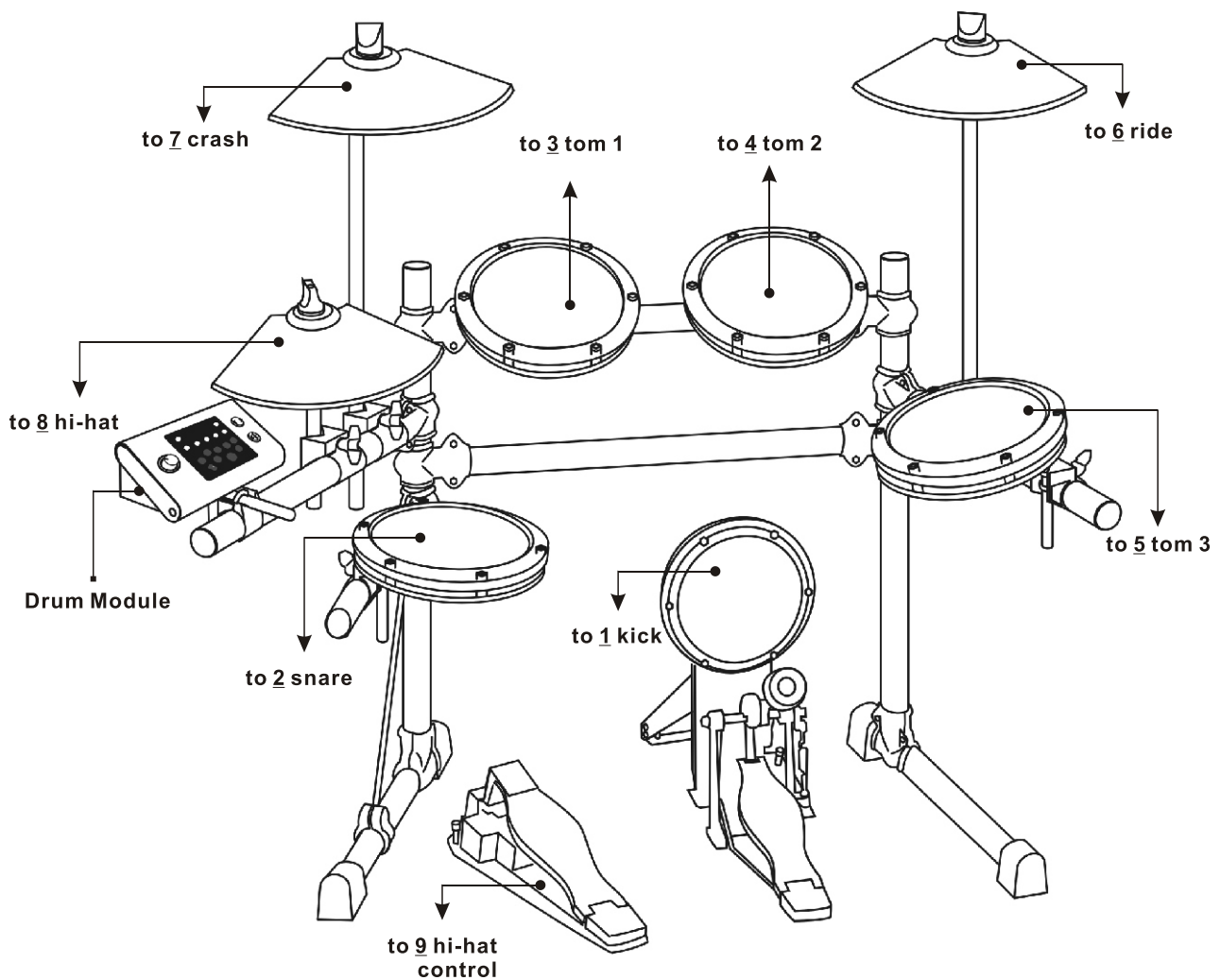

Connect a MIDI device

This is for you want to use an external sound module or MIDI sequencer.

Transmit MIDI Data

1. Use a MIDI cable to connect the MIDI OUT jack on the drum module with the MIDI IN jack on the external MIDI device.
2. This drum will output all the MIDI codes generated by pads hitting or pedal stepping via the MIDI output connector. But clicking and the MIDI codes in songs are excluded.

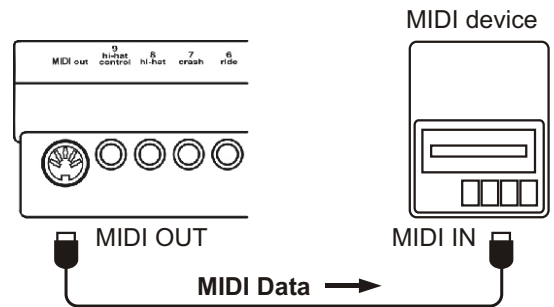

Connect a audio equipment

1. When you want to listen to the voices with an amplifier, connect amplifiers with the Output L/MONO and R jacks on the rear panel. (For monaural playback, use the L/MONO jack; for stereo playback, connect both L/MONO and R jacks.)
2. The volume is adjusted with the VOLUME knob.

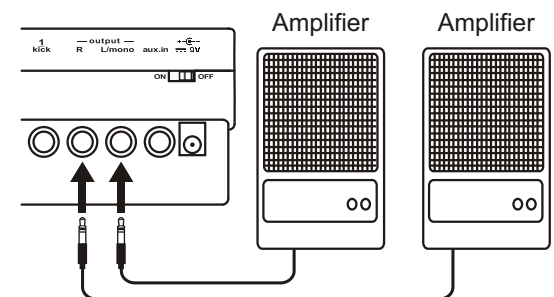

Connect a CD player, etc.(Aux. In jack)

1. The audio output of a CD player, or other audio source, to connect with the AUX IN jack on the rear panel can be mixed with the sound of the drum. This function is convenient that lets you play along with a favourite song.
2. The volume of the external signal is adjusted with the VOLUME knob.

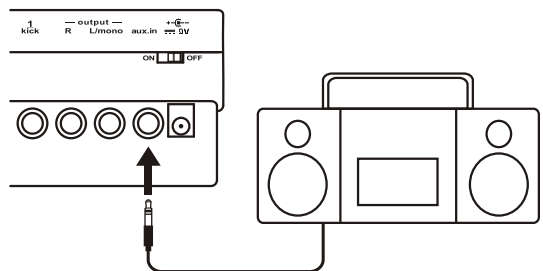

Connect Headphones

An optional set of stereo headphones can be connected with the PHONES jack located on the side of the drum module.

- * Adjust the volume to a comfortable level.

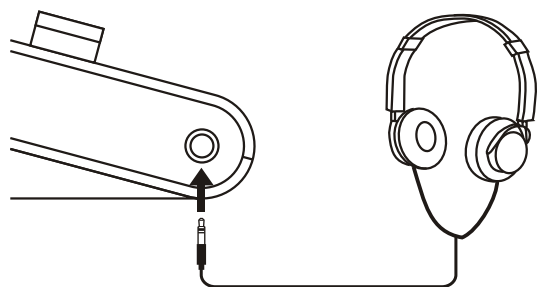

Connect the Power supply jack

Make sure the power is switched OFF and connect the power adaptor with the DC IN jack on the rear panel.

Note:

1. To protect the speakers, amplifier and the drum module from damage, rotate the volume knob to the minimum volume level before switching the power ON.
2. Make sure the power is switched OFF when connecting drum module with external devices.

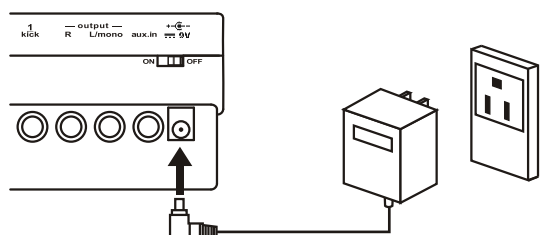

Functions

Switch the power ON

After confirming all connection have been completed, rotate the volume knob to the left (minimum volume level) before switching the power on.

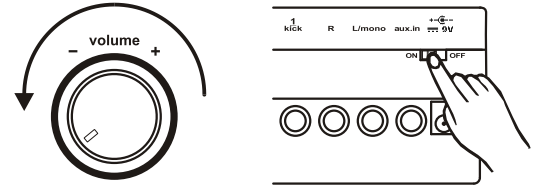

Set the power switch to "on" position to switch on the power. Display shows the song's number and its indicator lights up.



Set the main volume

While hitting a pad, gradually rotate the volume knob until a comfortable volume level is reached.

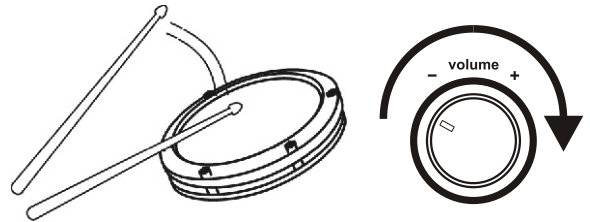

Select a drum kit

The unit comes with 20 (001-020) preset drum kits and 10 user kits (021-030). (Reference song list : page 14.)

1. Press [kit] button
The current kit number appears and the Kit indicator lights.
2. Press [+] or [-] buttons to select the drum kit number (001 - 020) you want to use.

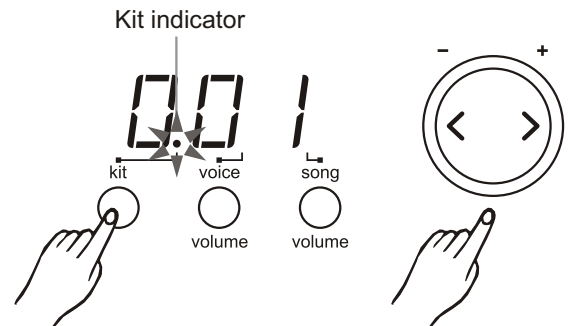

Play with a Metronome

1. Press the [click] button to start the metronome. The beat indicator is flashing and the click sound begins to play.
2. Press the [tempo +] or [tempo -] buttons to set the metronome beat.
3. Press the [click] button again to stop the metronome.

Adjust the volume of the click sound

Hold down the [click] button and press the [+] or [-] buttons to adjust the volume of the click sound, the metronome automatically play.

*When playing the metronome:

The metronome stops immediately when holding down [click] button, and pressing the [+] or [-] buttons on the click sound.

*Volume of the click sound will be reset to default once power is on.

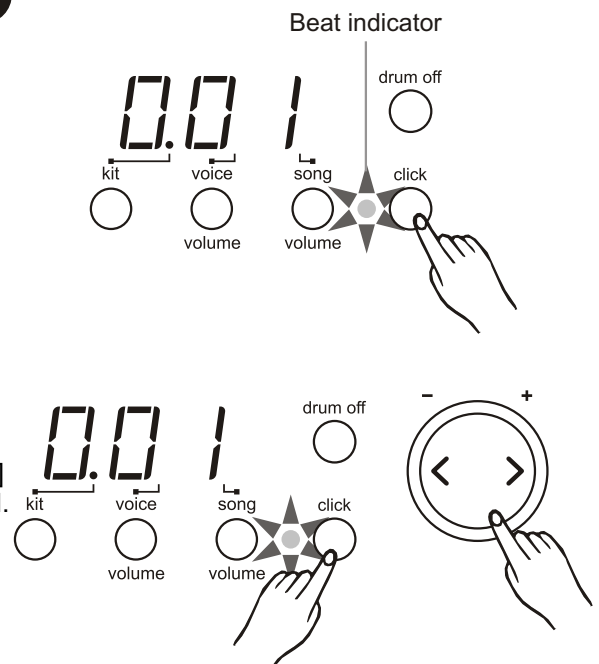

Play a Song

Select a song

This drum module has a total of 50 preset songs.
Note: The preset song setting is 001 after you slide on power.

1. Press [song / volume] button.
The song indicator lights and the current song's number appears.
2. Press [+] or [-] button to select one of the song and listen to it.
Song numbers 001 - 050 are preset songs.
(Reference song list : page 14.)

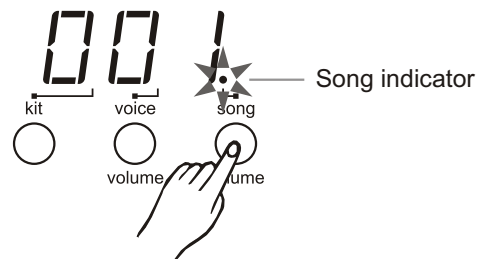

Listen to the song

1. Press [start/stop] button and the beat indicator is flashing.
After the counting, the song will start playback from the beginning.
 2. The song will stop when it reaches the end.
You can stop the song during playback by pressing the [start/stop] button
- * The ASSIGN pad's indicator flashes at the first beat of each measure

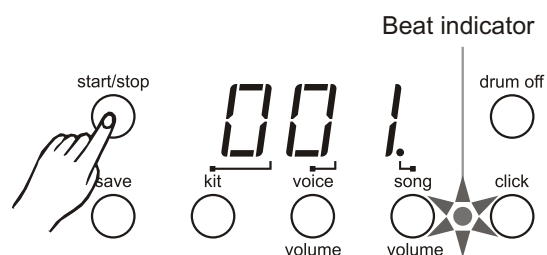

Note: The ASSIGN pad's indicator can be lighted off by pressing both [hi-hat] and [kick] button at the same time.

Adjust the song's volume

1. Press the [song / volume] button to select the volume of song. Display shows : "A XX".
(XX = level value, 00 to 31)
2. Press [+] or [-] button to adjust the volume of song accompaniment.

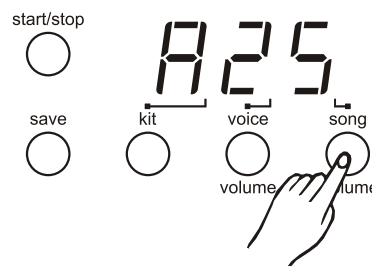

Adjust the song's tempo

1. Press the [tempo +] or [tempo -] button. Display shows the current tempo value.
 2. Press the [tempo +] or [tempo -] button to increase or decrease the tempo. (tempo value in the range or 30 to 280)
- * Holding down either a [tempo +] or [tempo -] button to change the setting in a high speed.
* Press [tempo +] and [tempo -] buttons at the same time to reset the tempo to default value.

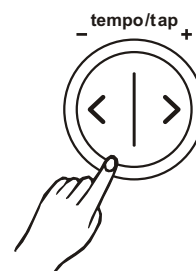

Note: About 2 seconds after you stop pressing the [Tempo] button, display changes to show your selected song or kit number instead of tempo value.

Tap tempo function

This function allows you to set the song's tempo by tapping in tempo on a pad.

1. Press the [tap] button. Display shows the current tempo value.
2. Tap on the pad in the tempo that you want to get. Tap on the pad 4 times. The last two beats are only detected and are set as your desired speed.
3. The song will be played with your desired tempo you set. When the song is playing, you are not allowed to change the tempo with this tempo function.

* Any pads can do the tap tempo function.

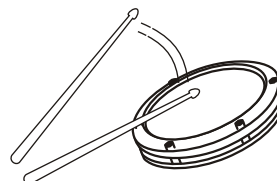
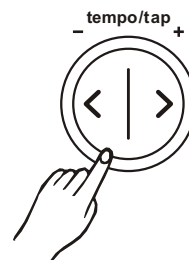

Mute a Drum part

1. Press [drum off] button. The drum off indicator lights. The drum mute function is active.
2. Press [start/stop] button to playback the song. The drum part in the song will be muted.
3. To cancel the drum mute function, press [drum off] button again. The drum off indicator light goes off.

* The drum mute function can be used during song playing.

Drum off indicator

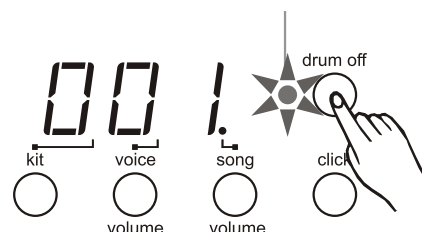

Play with the Click voice

1. Press the [click] button to start the metronome. It will be played with tempo.
2. Press the [click] button again to stop the metronome.

Note: The click voice will not stop automatically once the song finished until you press the [click] button.

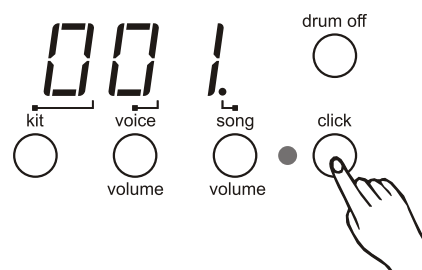

Use the lighting guide function

The lighting guide function provides you a valuable lesson to practice or learn the drum kit with playing the preset song.

1. Select the song number you want to practice.
2. Press [drum off] button.
3. Press [start/stop] button to start song play.
4. Strike the pad in accordance with the lighting of pad's indicators or press the hi-hat pedal and kick the bass drum pad exactly when their indicators light.

* During song playing, you can change the Tempo(speed), or use the tap tempo function to set your desired tempo.

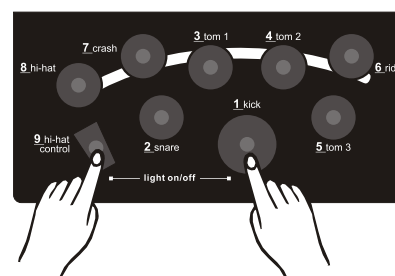

* Press the [hi-hat control] + [kick] buttons to turn off all the pad's indicator. Press the [hi-hat control] + [kick] buttons again to turn on all the pad's indicator.

Create a User Drum Kit

Set a drum voice

The unit comes with 215 high quality percussion sounds that you can assign to any of the drum pad, 3 cymbals, hi-hat control and bass drum. This way you can create your own drum kit that consists of the voice you want. (Reference voice list : page 13.) The kit number 021-030 is use for saving your own drum kit.

1. Press [voice] button.
The voice indicator lights and the display shows the voice number of this pad.
2. Press [pad] button or hit the pad you want to set. The pad indicator light and display shows the current voice number of lighting pad.
3. Press [+] or [-] buttons to select the voice number you want to assign.
4. Repeat step 2 and 3 for to set the voice for another pad or bass drum

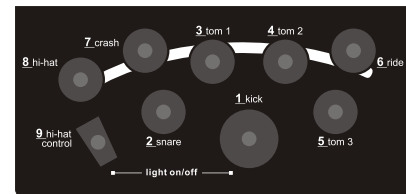

Pad buttons

Adjust the volume of Pad

This unit allows you to adjust the volume of every voices in the kit that let you control the individual level (volume) of the pads or bass drum.

1. Press the [voice / volume] button to select the volume level setting display shows : " L XX".
(XX = level value, 00 to 31)
The pad button indicator lights and display shows the current volume level of lighting pad.
3. Press the [PAD] button or kit the percussion pad you want to adjust.
4. Press the [+ / -] to increase or decrease the volume. While you are adjusting, hit the corresponding pad and listen carefully the sound level until reaching the level you want.
5. Repeat step 3 and 4 to adjust the volume of other pad voices.

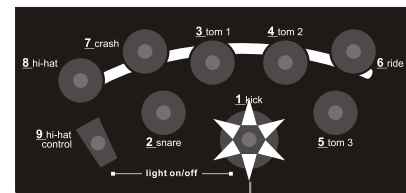
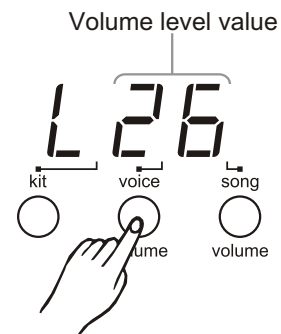

Pad indicator

Save your drum kit voices

Once completing to your own drum kit, you have to save them in the unit; otherwise your drum kit will be erased when you turn off the unit.

1. Press [save] button.
The kit number 021 appears and is flashing.
2. Press [+] or [-] button to set the kit number (021-030) for saving your drum kit.
3. Press [save] button again. The flashing kit number stops.

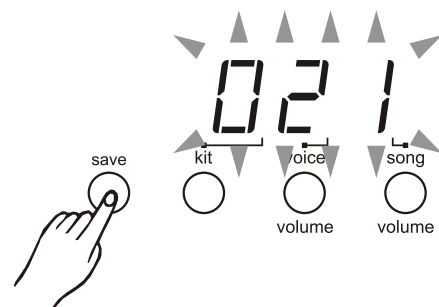

Note: To cancel the save operation, press the [voice] button.
If there is a fault, the display will show "Err".

Specifications

Drum Pad:	4 drum pads , 3 cymbal pads , 1 hi-hat control pedal , 1 kick trigger
Voices:	215 voices
Drum kits:	20 preset kits, 10 user kits
Song:	50 preset songs
Controls:	POWER SWITCH, START/STOP, SAVE, KIT, VOICE/VOLUME, SONG/VOLUME, DRUM OFF, CLICK, HI-HAT, CRASH, RIDE, HI-HAT CONTROL, SNARE, TOM 1, TOM 2, TOM3, KICK, VOLUME, + / -, TEMPO + / -, TAP
Display:	LED display
Connections:	MIDI OUT Hi-hat control Hi-hat Crash Ride Snare Tom 1 Tom 2 Tom 3 Kick Output (R & L/MONO) Aux in
Power Supply:	AC adaptor (≡ 9V)

Voice List

No. Name

Acoustic Base Drum

001 BD Head
 002 Real BD 1
 003 Real BD 2
 004 Real BD 6
 005 BD Std 1
 006 BD Std 2
 007 Room BD 1
 008 Room BD 2
 009 Lo BD
 010 Rock BD 1
 011 Rock BD 3
 012 Rock BD 4
 013 BD-Var 3
 014 BD-Var 5
 015 Big Drum 1
 016 Big Drum 2

Electronic Base Drum

017 BD-Analg
 018 MrDance 1
 019 MrDance 2
 020 MrDance 5
 021 Lo-BD 1
 022 Lo-BD 2
 023 Hard BD 3

Acoustic Snare Drum

024 SD-Std 1
 025 SD-Std 2
 026 SD-Std 3
 027 SD-Std 4
 028 SD-Std 5
 029 SD-R 1
 030 SD-R 2
 031 SD-R 5
 032 Snare 1
 033 Snare 2
 034 Snare 4
 035 Snare 5
 036 Snare 6
 037 SD-Std 21
 038 SD-Std 22
 039 SD-Std 23
 040 SD-Std 24
 041 SD-Std 25
 042 SD-Std 26
 043 SD-Std 27
 044 SD-Std 28
 045 SD-Std 29
 046 SnareDr 1
 047 SnareDr 5
 048 SnareDr 6
 049 SnareDr 7
 050 SnareDr 8
 051 SidStik 1
 052 SidStik 2
 053 SnarTimb

054 RowDrum 1
 055 RowDrum 2
 056 RowDrum 3

Electronic Snare Drum

057 SD-Ana 2
 058 SD-Ana 6
 059 SD-Ana 7
 060 SD-Ana 11
 061 SD-Danc 5
 062 SD-Danc 6
 063 SD-Elec
 064 Syn-SD 1
 065 Syn-SD 7
 066 Syn-SD 8
 067 Syn-SD 11
 068 Cool-SD 1
 069 HD-SD 1
 070 Brush 1
 071 Brush 2
 072 Brush 3
 073 Brush 5
 074 Brush 7
 075 Brush 8
 076 Brush 10
 077 Brush 13

Acoustic Tom

078 Tom-Std 5
 079 Tom-Std 3
 080 Tom-Std 2
 081 Tom-Std 1
 082 Tom-Jaz M
 083 Tom-Jaz F
 084 Tom-Brs H
 085 Tom-Brs M
 086 Tom-Brs L
 087 Tom-Brs F
 088 Tom-BRK H
 089 Tom-BRK M
 090 Tom-BRK L
 091 Tom-BRK F
 092 Tom-Rom 6
 093 Tom-Rom 5
 094 Tom-Rom 4
 095 Tom-Rom 3
 096 Tom-Rom 2
 097 Tom-Rom 1
 098 Tom-Rm 2 L
 099 Tom-Rm 2 F

Electronic Tom

100 TomH-A
 101 Tom-A 5
 102 Tom-A 4
 103 Tom-A 3
 104 Tom-A 2
 105 Tom-A 1
 106 Tom-T 1 M

107 Tom-T 3 L
 108 Tom-T 3 F
 109 Tom-EI 4
 110 Tom-EI 3
 111 Tom-EI 2
 112 Tom-EI 1

Cymbal

113 CrashStd
 114 CrashBrt
 115 CrashSt 2
 116 SftCrash
 117 CrashSt 3
 118 CrashSht
 119 CrshThin
 120 CrashRev
 121 CrashRol
 122 CrashSt 4
 123 RideBel 1
 124 RK Ride 2
 125 RideBStd
 126 Splash C 1
 127 Cymbel 2
 128 Cymbel 3
 129 BigGong 1
 130 BigGong 2
 131 B.Cymb1 1
 132 B.Cymb1 2
 133 S.Cymb1 2
 134 S.Cymb 2 M
 135 SmalGong

Hi-Hat

136 H.H Cls 1
 137 H.H Cls 3
 138 H.H Cls 4
 139 H.H Opn 1
 140 H.HCNor 1
 141 RK HHcls
 142 H.H Opn 3
 143 Open HH 2
 144 Open HH 3
 145 Open HH 4
 146 RK HHOpn
 147 Open HH 7
 148 HH pedl 1
 149 HH pedl 2
 150 Ana Hh 1

Percussion

151 Agogo-1
 152 Agogo-2
 153 Bell Tre
 154 Bongo Hi
 155 Bongo Lo
 156 Cabasa 1
 157 Cabasa 2
 158 Castanet
 159 ClapA

160 Clavis 1
 161 Clavis 2
 162 Conga-Hi
 163 Conga-M 1
 164 Conga-M 2
 165 Conga-3
 166 Conga-4
 167 Conga-5
 168 CowBell 1
 169 CowBell 2
 170 Cuica H
 171 Cuica L
 172 Fsnap
 173 Guiro 1
 174 Guiro 2
 175 HiQ
 176 JingBell
 177 Maracas 1
 178 Maracas 2
 179 MetroBel
 180 MetroClk
 181 Scrach
 182 Shake
 183 Surdo 1
 184 Surdo 2
 185 Tabla 1
 186 Tabla 2
 187 Tabla 3
 188 Tabla 4
 189 TalkD
 190 TalknDrD
 191 TalknDrU
 192 TalknDrV
 193 Tambouri
 194 TimpleH
 195 TimpleL
 196 TimplePH
 197 TimplePL
 198 Triangle
 199 TriagMut
 200 VibrSlap
 201 Whistal
 202 XfadeTri
 203 Smallwod
 204 BoardDr 1
 205 BoardDr 2
 206 LotusBrd
 207 BanbuBrd
 208 SouthBan
 209 B.WdFish
 210 S.WdFis 1
 211 S.WdFis 2
 212 S.WdFis 3
 213 S.WdFis 4
 214 ImpacBel
 215 ImpaBel M

Drum Kit List

No.	Name	No.	Name
001	Standard 1	011	Jazz
002	Standard 2	012	Brush 2
003	Dance 1	013	Dance Stick
004	Jazz Latin	014	Orchestra
005	Room 1	015	Drum & Bass
006	Electric	016	House
007	Brush	017	Rhythm & Blues
008	Room Stick	018	Ungle
009	Latin 1	019	China LuoGu
010	Latin 2	020	Oriental 1

Song List

No.	Name	Beat	No.	Name	Beat
001	Guitar	4/4	026	Reggae	4/4
002	Accordion Fusion	4/4	027	Shuffle 1	4/4
003	Folk Pop	4/4	028	Rhythm & Blues 3	4/4
004	Rock	4/4	029	Rock 'N' Roll 1	4/4
005	Blues	4/4	030	8 Beat 4	4/4
006	Newage	4/4	031	8 Beat 2	4/4
007	Reggae Funk	4/4	032	16 Beat	4/4
008	Drum & Bass	4/4	033	March	4/4
009	Pop 8 Beat	4/4	034	Latin 6	4/4
010	Dance	4/4	035	Funk 3	4/4
011	Drk -2	4/4	036	Fusion 2	4/4
012	Pop 3	4/4	037	Rock 'N' Roll 2	4/4
013	Pop 5	4/4	038	Hard Rock 3	4/4
014	Jazz 1	4/4	039	Rock Pop 2	4/4
015	Rhythm & Blues 4	6/8	040	Funk 1	4/4
016	Ballad 1	4/4	041	Funk 4	4/4
017	Ballad 2	4/4	042	Jazz 3	6/8
018	Ballad 4	4/4	043	Dance 1	4/4
019	Ballad 5	4/4	044	Dance 2	4/4
020	Ballad 6	4/4	045	Mambo	4/4
021	Waltz	3/4	046	Rhythm & Blues 1	4/4
022	Slow Rock	6/8,9/8	047	Rhythm & Blues 2	4/4
023	Rock Pop 4	4/4	048	Ballad 3	4/4
024	Latin 4	4/4	049	Jing Opera	4/4
025	Latin 5	4/4	050	Chinese Rhythm	2/4

MIDI Implementation Chart

	Function...	Transmitted	Remarks
Basic	Default	10 ch	
Channel	Changed	X	
Mode	Default	X	
	Messages	X	
	Altered	*****	
Note		0 - 127	
Number:	True voice	*****	
Velocity	Note on	O 9nH, V= 1 - 127	
	Note off	X (9nH. V= 0)	
After	Key's	X	
Touch	Channel's	X	
Pitch Bend		X	
Control	0	X	Bank Select
Change	1	X	Modulation
	5	X	Portamento Time
	6	X	Data Entry
	7	X	Volume
	10	X	Pan
	11	X	Expression
	64	X	Sustain Pedal
	65	X	Portamento ON/OFF
	66	X	Sostenuto Pedal
	67	X	Soft Pedal
	80	X	Reverb Program
	81	X	Chorus Program
	91	X	Reverb Level
	93	X	Chorus Level
	120	X	All Sound OFF
	121	X	Reset All Controller
	123	X	All Notes OFF
Program		X	
Change:	True #	X	
System	Exclusive	X	
System	: Song Position	X	
Common	: Song Select	X	
	: Tune	X	
System	: Clock	X	
Real Time	: Commands	X	
Aux	: Local ON/OFF	X	
	: All Notes OFF	X	
Messages	: Active Sense	X	
	: Reset	X	

O : YES

X : NO

