



# Congratulations!

Thank you for purchasing this Portable Digital Drum, The Digital Drum is developed to act and play like a drum but with greater ease. Before you use the instrument, we recommend you to read through this manual.

## Taking Care of Your Portable Digital Drum

Your Digital Drum will give you years of playing pleasure if you follow the rules shown below:

### Location

- Do not expose the unit to the following conditions to avoid deformation, discoloration, or more serious damage.
- Direct sunlight.
- High temperature (near a heat source, or in a car during the day time).
- Excessive humidity.
- Excessive dust.
- Strong vibration

### Power Supply

- Turn the power switch OFF when the instrument is not in use.
- If an AC adaptor is used, it should be unplugged from the AC outlet if the instrument is not to be used for an extended period of time.
- Unplug the AC adaptor during electric storms.
- Avoid plugging the AC adaptor into the same AC outlet as appliance with high power consumption, such as electric heaters or ovens. Also avoid using multi-plug adaptors since these can result in reduced sound quality, operation errors, and possibly damage.

### Turn Power OFF When Making Connections

- To avoid damage to the instrument and other devices to which it is connected, turn off the power switches of all related device prior to connecting or disconnecting cables.

### Handling and Transport

- Never apply excessive force to the controls, connectors or other parts of the instrument.
- Always unplug cables by gripping the plug firmly, but not pulling on the cable.
- Disconnect all cables before moving the instrument.
- Physical shocks caused by dropping, bumping, or placing heavy objects on the instrument can result in scratches and more serious damage.

### Cleaning

- Clean the cabinet and panel with a dry soft cloth.
- A slightly damp cloth may be used to remove stubborn grime and dirt.
- Never use cleaners such as alcohol or thinner.
- Avoid placing vinyl object on top of the unit (vinyl can stick to and discolor the surface).

### Electrical Interference

- This instrument contains digital circuitry and may cause interference if placed too close to radio or television receivers. If this occurs, move the instrument further away from the affected equipment.

THIS DEVICE COMPLIES WITH PART 15 OF THE FCC RULES. OPERATION IS SUBJECT TO THE FOLLOWING TWO CONDITIONS:  
(1) THIS DEVICE MAY NOT CAUSE HARMFUL INTERFERENCE, AND  
(2) THIS DEVICE MUST ACCEPT ANY INTERFERENCE RECEIVED, INCLUDING INTERFERENCE THAT MAY CAUSE UNDESIRABLE OPERATION.

# Contents

<b>Panel Controls</b> .....	<b>4-5</b>
- Top Panel .....	4
- Rear Panel .....	5
<b>Operation</b> .....	<b>6</b>
- Select a Drum Kit .....	6
- Set Pad Voice .....	6
- Set pad volume .....	6
- Set pad pan .....	7
- Set pad gain .....	8
- Save Kit .....	8
- Play Song .....	9
- Main Volume .....	9
- Accompaniment Volume .....	9
- Drum Off .....	9
- Tempo .....	10
- Metronome .....	10
- Hand Percussion .....	10
- Demo .....	10
- Reverb .....	11
- Record .....	11
- Playback .....	11
<b>Input and Output</b> .....	<b>12</b>
- Pedals .....	12
- Phones output .....	12
- USB jack .....	12
<b>Appendix</b> .....	<b>13</b>
- Voice list .....	13-14
- Kits list .....	15
- Song list .....	15-16
<b>MIDI implementation chart</b> .....	<b>17</b>
<b>Specifications</b> .....	<b>18</b>

# Setting up

## Power Supply

Your digital drum **will run on either batteries or power adaptor.** Follow the instructions below according to the power source you intend to use.

### Using an AC- Adaptor

Connect the power adaptor to the DC IN jack located on the rear panel of the unit, and plug the AC power adaptor into an AC power outlet.

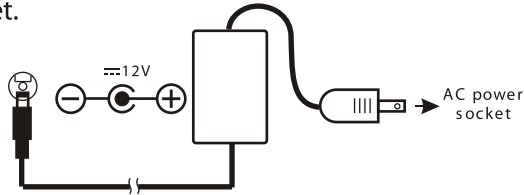

**Do not use adaptors other than the one specified. The technical specification of the adaptor is DC 12V output, center positive type.**

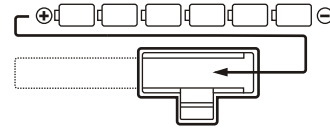

**3** Close the battery compartment securely.

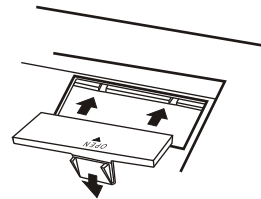

### Using Batteries

**1** Open the battery compartment cover on the underside of the unit.

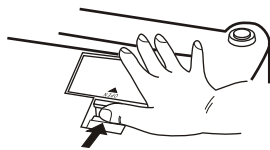

**2** Insert six "C" size, R14, SUM-2 or equivalent batteries. When inserting the batteries, be care to follow the polarity markings in the illustration.

**Note: we suggest to use the alkaline batteries.**

**NOTES**

- Power will be automatically drawn from the AC adaptor if an optional AC adaptor is connected while batteries are installed in the instrument.

**CAUTION**

- It is recommended that you replace worn batteries as soon as possible. When battery voltage drops, the display will dim and / or the sound will become distorted, when this occurs, replace the batteries with a complete set of six new batteries of the same type.

- NEVER mix old and new batteries, different types of batteries (alkaline, magnesium, etc.), Batteries by different makers, or batteries from the same maker but of different types. Misuse may cause the instrument to become hot, result in fire, or battery leakage.

Also, to prevent damage due to battery leakage, remove all the batteries from the instrument when it is not to be used for an extended period of time. Batteries left in an unused instrument will also loose their power overtime.

## Using Headphones

An optional set of stereo headphones can be connected to the PHONES/OUTPUT jack located on the rear panel. When a pair of headphones is connected to the jack, the internal speakers of the unit will switch off automatically, perfect for private practice or late night playing. If you want to use an external sound system, the headphone jack can also be used to connect the digital drum to a stereo system or mixing console.

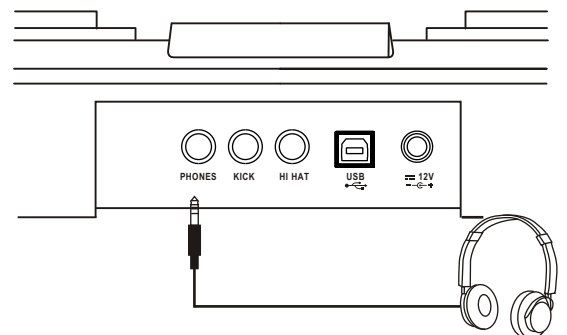

\* Turn off the power on all equipment before making any connections.

# Panel Controls

## Top panel

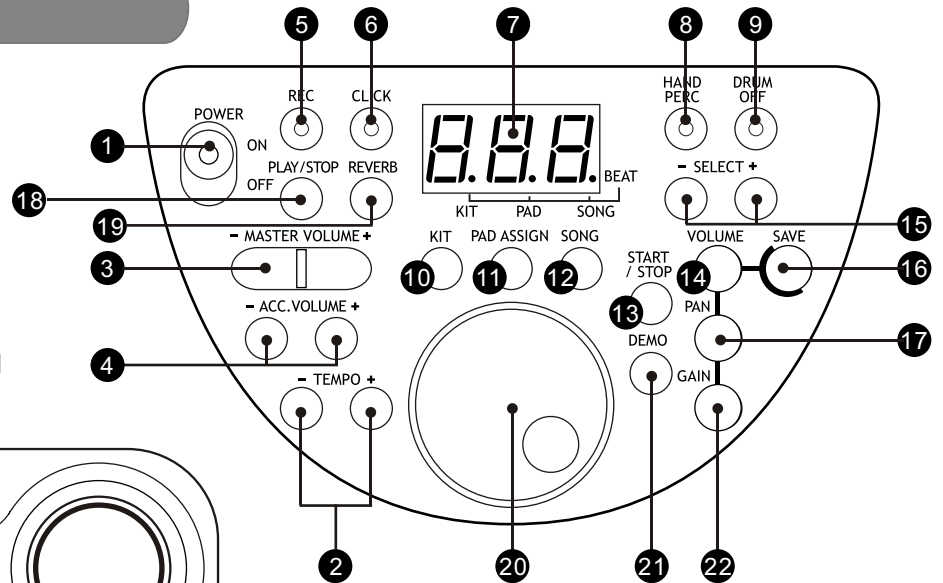
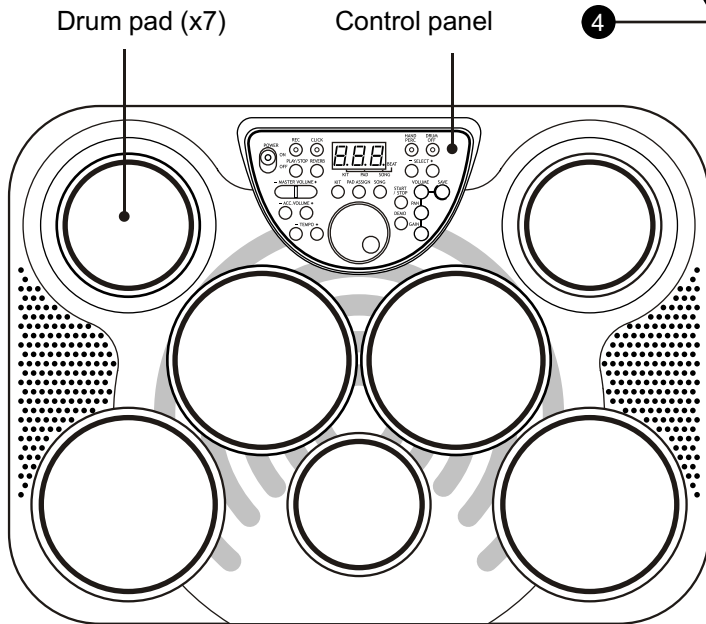

### 1.power on---off

This switch turns power on/off.

### 2.tempo + & -

These buttons are used to change current tempo.

### 3.master volume + & -

These buttons can be used to change the master volumes.

### 4.acc. Volume + & -

These buttons can be used to change the accompaniment volumes.

### 5.rec and LED indicator

This button can be used to start or stop recording.

### 6.click and LED indicator

This button is used to turn on or off the metronome.

### 7.3-digit LED

This LED is the main display device of DD-305, which will show the parameters of current menu.

### 8.hand percussion and LED indicator

This button can be used to turn on the hand percussion function.

### 9.drum off and LED indicator

This button is used to enable or disable drum off function.

### 10.kit

This button is used to enter kit menu.

### 11.pad assign

This button is used to enter voice or volume menu.

### 12.song

This button is used to enter song menu.

### 13.start/stop

This button can be used to start or stop song playing.

### 14.volume

This button can be used to change the volume of pad.

### 15.select + & -

These buttons can be used to change values (kit number, voice number, song number, etc.) When editing.

### 16.save

This button is used to save current kit setting to a user kit.

### 17.pan

This button can be used to change the pan of pad.

### 18.play/stop

This button can be used to start or stop recording replay.

**19.reverb**

This button is used to change the reverb level.

**20.dial**

This button can be used to change values (kit number, voice number, song number, etc.) when editing.

**21.demo**

This button can be used to start or stop demo song playing.

**22.gain**

This button can be used to change the gain of pad.

**Rear Panel**

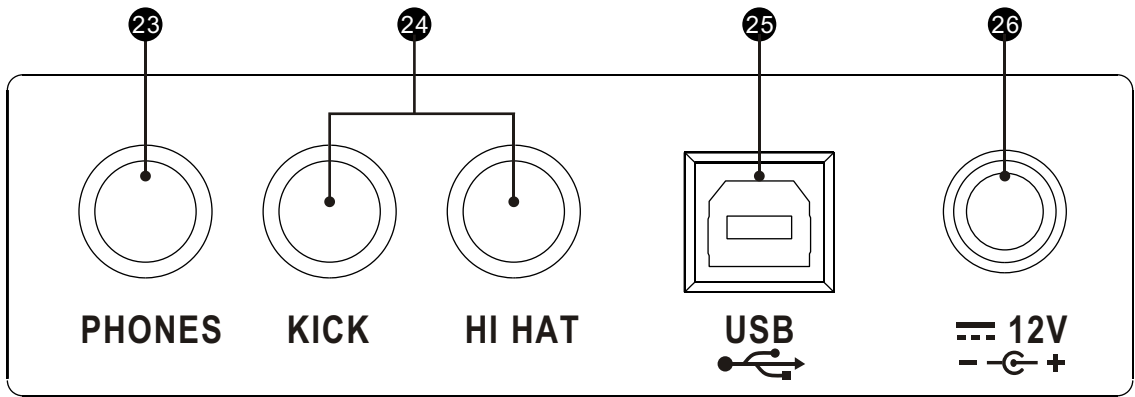

**23.Phones jack**

This jack is used to connect with headphones

**24.Pedal input jacks**

Kick and hi-hat pedal input jacks.

**25.USB jack**

This port is used to connect with external device.

**26.DC input**

Connect to a DC 12V.

# Operation

## Select a Drum Kit

Kit menu is the default menu after power on, default value is 001.

Press [kit] button to enter kit menu. The 3-digit LED will show the current kit number with the corresponding menu indicator lit up. The button select [+]/[-] or [dial] can be used to select any kit (1-30, loop) as current kit.

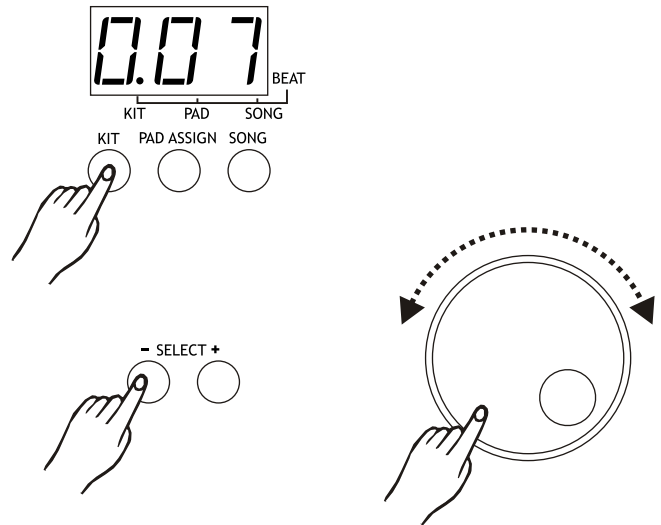

## Set Pad Voice

Press [pad assign] button to enter **pad assign menu**. Default value will be the voice value of crash pad based on different kit selected. For example, if kit 001 has been selected, then press pad assign, the value on LED will be 96, as this is the voice value on crash pad.

If **pad assign menu** is selected the corresponding menu indicator will be lit up.

In this menu, the 3-digit LED will show the voice number of current pad, which can be selected by pressing pad button on the top panel or by pad hitting. The button select [+]/[-] or [dual] can be used to select any voice (1-215, loop) for current pad.

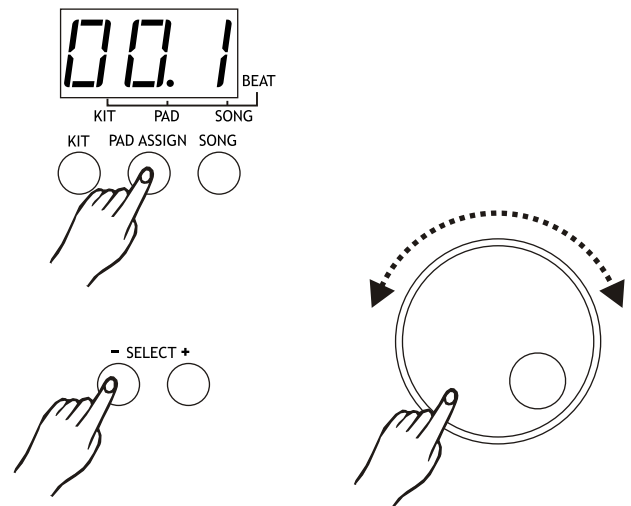

## Set pad volume

Press [volume] button to enter pad assign menu. If pad assign menu is selected, the corresponding menu indicator will be lit up.

In this menu, the 3-digit LED will show the volume of current pad, which can be selected by pressing pad button on the top panel or by pad hitting. The button select [+]/[-] or [dial] can be used to select the volume (0-9, loop) for current pad.

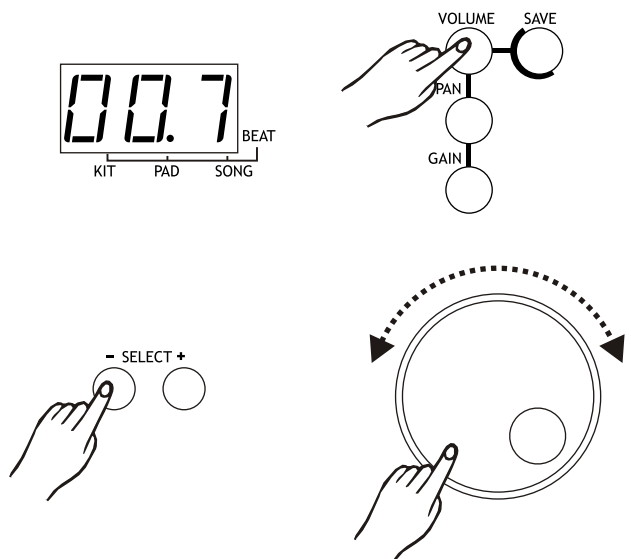

## Set pad pan

Press [pan] button to enter pad assign menu. If pad assign menu is selected, the corresponding menu indicator will be lit up.

In this menu, the 3-digit LED will show the pan of current pad, which can be selected by pressing pad button on the top panel or by pad hitting. The button select [+]/[-] or [dial] can be used to select the pan (0-9, loop) for current pad.

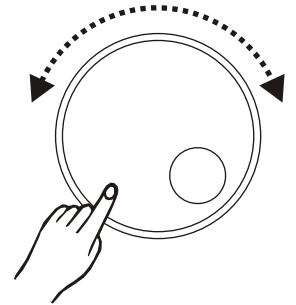
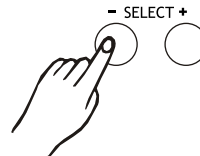
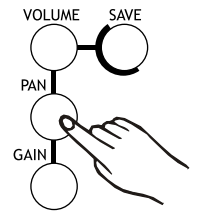
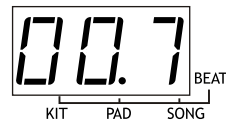

## Set pad gain

Press [gain] button to enter pad assign menu. If pad assign menu is selected, the corresponding menu indicator will be lit up.

In this menu, the 3-digit LED will show the gain of current pad, which can be selected by pressing pad assign button on the top panel or by pad hitting. The button select [+]/[-] or [dial] can be used to select the gain (0-9, loop) for current pad.

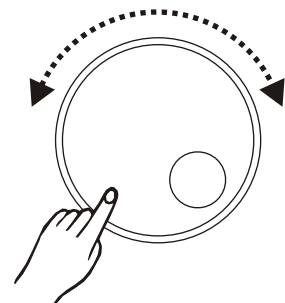
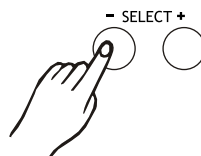
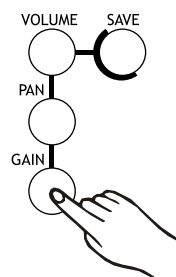

## Save Kit

Press [save] button to enter the kit save menu. The button select [+]/[-] or [dial] can be used to select a user kit (21-30, loop) current kit setting. During kit selecting the user kit number will keep flashing.

Press [save] button again, the current kit setting will be saved to the selected kit. The machine will quit to the kit menu and select this user kit as the current one, if all the data has been saved successfully.

If saving is failed due to error, an 'Err' will appear on the LED.

**NOTE:**  
The unsaved kit setting will be lost after kit changing.

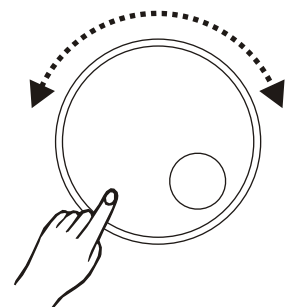
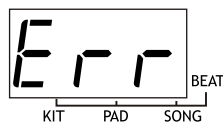
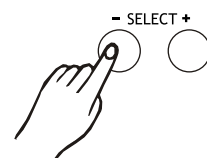
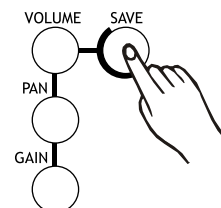

## Play Song

Press [song] button to enter song menu. Default value is 001, The 3-digit LED will show current song number with corresponding menu indicator lit up. The button select [+]/[-] or [dial] can be used to select current song ( 1-100, loop ). First 80 styles are loop playing. Press [start / stop ] to start or stop the song player. If song is switched while it's playing, the new song will not start until the end of current measure.

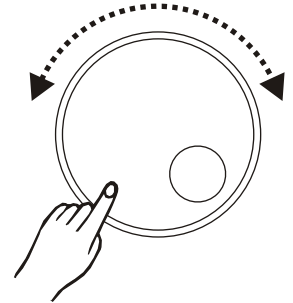
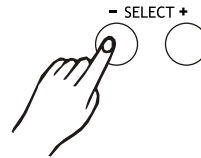

Each song has its own default tempo and drum kit, the song player will initialize the current kit and current tempo at the beginning of song playing.

## Main Volume

In main volume menu, the digit on far left of LED will display letter 'L'. The two digits on the right will display current main volume. The button select Master Volume [+]/[-] can be used to adjust the volume ( 0-9, not loop ). And this value will be auto-saved after adjusted.

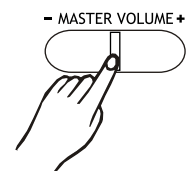

## Accompaniment Volume

In accompaniment volume menu, the digit on far left of LED will display letter 'A'. The two digits on the right will display current accompaniment volume. The button select [+]/[-] or [dial] can be used to adjust the volume ( 0-9, not loop ). This value will be auto-saved after adjusted.

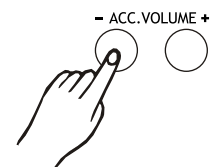

## Drum Off

Pressing [ drum off ] button will enable or disable the drum off function when a song is playing. If drum off is enabled, the drum voice will be turned off with the drum off indicator lit on. This function is quite useful for practicing.

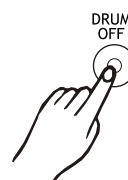

## Tempo

Press the tempo [+] and [-] button to enter the tempo menu. Button [+] and [-] can be used to change current tempo ( 30-280, not loop ), which affects the speed of clicking, and song playing. Press both [+] and [-] will reset current tempo to its default value (current song tempo).

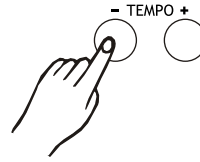

## Metronome

The metronome will run once a song is playing but with only indicator flashing. Press once on [ click ] button for human voice counting. Press twice on [click] for clicking sound. Press again to turn off the clicking.



## Hand Percussion

Press [hand perc] button to enter the hand percussion mode with the hand mode indicator lit up. The song number is 5 and the kit number is 21.

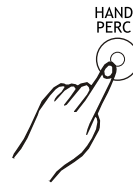

## Demo

Press [demo] button to start or stop demo song playing. The 3-digit LED will display ※dE\$, you can also press [ start / stop ] button to stop demo song playing.



## Reverb

Press [ reverb ] button to enter reverb function. In this menu, the digit on far left of LED will display letter 'R'. The two digits on the right will display current reverb level. The button select [ + ] / [ - ] or [ dial ] can be used to adjust the reverb level (0-3, not loop). This value will be auto-saved after adjusted.

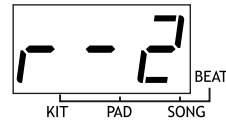

## Record

### Prepare to Record

Select the desired song, drum kit, tempo, drum off setting, and reverb settings.

### Start Recording

Press the [rec] button, the light start flashing. Press the [start/stop] button or strike the pad, the light stop flashing and the recording process starts.



### Stop Recording

To stop recording, press the [start / stop] button or [ rec ] button. The record indicator will turn off. If the memory is full, "FL" will appear on the display and recording process stops automatically.

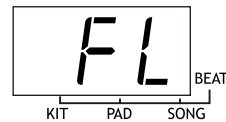

*Note: When you start the recording, the vocal metronome also starts to count. But the sound of the vocal will not be record. To stop the metronome, press the [click] button.*

## Playback

Press the [play/stop] button will start or stop playing recorded song.

*Note: When you record a new song, it will replace the previous recording. The song data recorded will be lost when you turn off the power.*



# Input and Output

## Pedals

this appliance supports 1 hi-hat pedal and 1 kick pedal as input device.

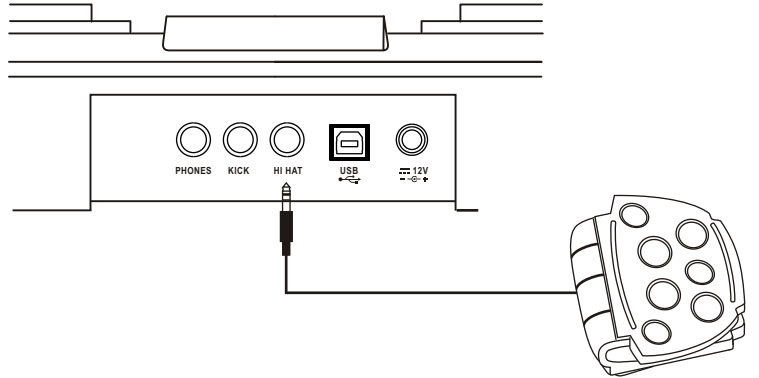

## Phones output

The phones output supports a stereo headphones as output device.

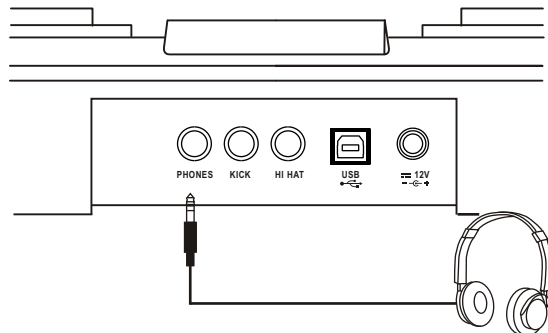

## USB jack

this appliance will output all the MIDI codes generated by pads hitting or pedal stepping via the MIDI output connector. clicking and the MIDI codes in songs are excluded. It's also receive the MIDI data from external device.

# Appendix

## Voice list

NO.	NAME	NO.	NAME	NO.	NAME
	Kick KIT	35	Pop Snare 001	70	Acoustic Tom 004
1	Rock Kick 001	36	Pop Snare 002	71	Acoustic Tom 005
2	Rock Kick 002	37	Pop Snare 003	72	Acoustic Tom 006
3	Rock Kick 003	38	Acoustic Snare 001		Hihat KIT
4	Standard Kick 001	39	Acoustic Snare 002	73	Standard Hihat Close
5	Standard Kick 002	40	Acoustic Snare 003	74	Standard Hihat Pad
6	Standard Kick 003	41	Acoustic Snare 004	75	Standard Hihat Open
7	Standard Kick 004	42	Acoustic Snare 005	76	Analog Hihat Close
8	Pop Kick 001		Tom KIT	77	Analog Hihat Pad
9	Pop Kick 002	43	Standard Tom 001	78	Analog Hihat Open
10	Pop Kick 003	44	Standard Tom 002	79	Shakable
11	Acoustic Kick 001	45	Standard Tom 003	80	Rock Hihat Close
12	Acoustic Kick 002	46	Standard Tom 004	81	Rock Hihat Pad
13	Acoustic Kick 003	47	Standard Tom 005	82	Rock Hihat Open
14	Acoustic Kick 004	48	Standard Tom 006	83	Acoustic Hihat Close
15	Acoustic Kick 005	49	Room Tom 001	84	Acoustic Hihat Pad
16	Acoustic Kick 006	50	Room Tom 002	85	Acoustic Hihat Open
17	Acoustic Kick 007	51	Room Tom 003		Crash KIT
18	Acoustic Kick 008	52	Room Tom 004	86	Standard Crash001
19	Acoustic Kick 009	53	Room Tom 005	87	Standard Crash002
20	Acoustic Kick 010	54	Room Tom 006	88	Standard Crash003
21	Acoustic Kick 011	55	Electronic Tom 001	89	Analog Ride001
	Snare KIT	56	Electronic Tom 002	90	China Crash
22	Standard Snare 001	57	Electronic Tom 003	91	Splash001
23	Standard Snare 002	58	Electronic Tom 004	92	Standard Ride 001
24	Standard Snare 003	59	Electronic Tom 005	93	Rock Crash
25	Standard Snare 004	60	Electronic Tom 006	94	Standard Ride 002
26	Standard Snare 005	61	Analog Tom 001	95	Electronic Crash
27	Standard Snare 006	62	Analog Tom 002	96	Splash002
28	Brush Snare 001	63	Analog Tom 003	97	Ride Bell
29	Brush Snare 002	64	Analog Tom 004		Panel KIT
30	Standard Stick 001	65	Analog Tom 005	98	Vibraslap
31	Standard Stick 002	66	Analog Tom 006	99	Hand
32	Rock Snare 001	67	Acoustic Tom 001	100	Tambourine
33	Rock Snare 002	68	Acoustic Tom 002	101	Stcowb
34	Rock Snare 003	69	Acoustic Tom 003	102	Mutecowb

NO.	NAME	NO.	NAME	NO.	NAME
103	Mute Hi Conga	141	Tambourine001	178	SFX033
104	Open Hi Conga	142	Tambourine002	179	SFX034
105	Low Conga	143	Tambourine003	180	SFX035
106	Hi Bongo	144	Tambourine004	181	SFX036
107	Low Bongo	145	Tambourine005	182	SFX037
108	High Timbale	Sfx KIT		183	SFX038
109	Low Timbale	146	SFX001	184	SFX039
110	High Agogo	147	SFX002	185	SFX040
111	Low Agogo	148	SFX003	186	SFX041
112	Cabasa	149	SFX004	187	SFX042
113	Shaker	150	SFX005	188	SFX043
114	Claves	151	SFX006	189	SFX044
115	Mute Triangle	152	SFX007	190	SFX045
116	Open Triangle	153	SFX008	191	SFX046
117	Short Guiro	154	SFX009	192	SFX047
118	Long Guiro	155	SFX010	193	SFX048
119	Mute Cuica	156	SFX011	194	SFX049
120	Open Cuica	157	SFX012	195	SFX050
121	Mute Surdo	158	SFX013	196	SFX051
122	Open Surdo	159	SFX014	197	SFX052
123	Maracas	160	SFX015	198	SFX053
124	HighQ	161	SFX016	199	SFX054
125	Slap	162	SFX017	200	SFX055
126	Scratch Push	163	SFX018	201	SFX056
127	Scral	164	SFX019	202	SFX057
128	One	165	SFX020	203	SFX058
129	Two	166	SFX021	204	SFX059
130	Three	167	SFX022	205	SFX060
131	Four	168	SFX023	206	SFX061
132	Cartoon001	169	SFX024	207	SFX062
133	Cartoon002	170	SFX025	208	SFX063
134	Cartoon003	171	SFX026	209	SFX064
135	Cartoon004	172	SFX027	210	SFX065
136	Cartoon005	173	SFX028	211	SFX066
137	Cartoon006	174	SFX029	212	SFX067
138	Laugh	175	SFX030	213	SFX068
139	Metronome1	176	SFX031	214	SFX069
140	Metronome2	177	SFX032	215	SFX070

## Kits list

NO.	NAME	NO.	NAME
01	Pop1	16	Jazz2
02	Pop2	17	Funk
03	Standard 1	18	Clave
04	Room	19	Drum Bass
05	Rock 1	20	Hip Hop
06	Electronic	21	Conga1
07	Analog	22	Conga2
08	Jazz 1	23	Timbales
09	Brush	24	Latin
10	Standard 2	25	Funk
11	Rock2	26	User 1 (pop1)
12	Boss	27	User 2 (pop2)
13	Rock3	28	User 3 (Standard1)
14	Standard 3	29	User 4 (Room)
15	Rock4	30	User 5 (Rock1)

## Song list

NO.	KIT	NAME	BEAT
Intro			
01	01	Intro	4/4
8 Beat			
02	03	8 Beat2	4/4
03	02	8 Beat3	4/4
04	05	8 Beat4	4/4
05	21	8 Beat5	4/4
06	21	8 Beat Ballad1	4/4
07	21	8 Beat Ballad2	4/4
08	01	8 Beat Ballad3	4/4
09	03	Soft Rock	4/4
10	04	Rock1	4/4
11	05	Rock2	4/4
12	03	Rock3	4/4
13	01	Rock4	4/4
14	02	Rock5	4/4
15	05	Hard Rock1	4/4

NO.	KIT	NAME	BEAT
16	05	Hard Rock2	4/4
17	07	16 Beat 1	4/4
18	03	16 Beat 2	4/4
19	01	16 Beat 3	4/4
20	07	16 Beat 4	4/4
21	04	16 Beat 5	4/4
22	02	16 Beat 6	4/4
23	01	16 Beat 7	4/4
24	21	16 Beat Ballad 1	4/4
25	21	16 Beat Ballad 2	4/4
26	05	16 Beat Ballad 3	4/4
27	03	16 Beat Ballad 4	4/4
28	01	16 Beat Ballad 5	4/4
29	03	16 Beat Funk 1	4/4
30	01	16 Beat Funk 2	4/4

NO.	KIT	NAME	BEAT
Dance			
31	07	Dance 1	4/4
32	07	Dance 2	4/4
33	01	Dance 3	4/4
34	06	Dance 4	4/4
35	04	Dance 5	4/4
36	07	Dance 6	4/4
Rap			
37	03	Rap 1	4/4
38	01	Rap 2	4/4
39	03	Rap 3	4/4
Bounce			
40	04	Bounce 1	4/4
41	03	Bounce 2	4/4
42	01	Bounce 3	4/4
Shuffle			
43	03	Shuffle 1	4/4
44	02	Shuffle 2	4/4
45	03	Shuffle 3	4/4
46	01	Shuffle 4	4/4
47	05	Shuffle 5	4/4
48	04	Shuffle 6	4/4
49	03	Shuffle 7	4/4
Slow Rock			
50	03	Slow Rock 1	4/4
51	04	Slow Rock 2	4/4
52	01	Slow Rock 3	4/4
53	04	Slow Rock 4	4/4
Latin			
54	03	Reggae 1	4/4
55	23	Reggae 2	4/4
56	12	Bossa Nova 1	4/4
57	12	Bossa Nova 2	4/4
58	03	Samba	4/4
59	01	Salsa	4/4
60	03	Latin Rock	4/4
61	03	Cha-Cha	4/4
62	12	Mambo	4/4
63	12	Rhumba 1	4/4
64	12	Rhumba 2	4/4
65	12	Rhumba 2	4/4
66	01	Tango	4/4

NO.	KIT	NAME	BEAT
Swing			
67	09	Swing 1	4/4
68	09	Swing 2	4/4
69	08	Swing 3	4/4
Others			
70	12	Waltz	4/4
71	02	3/4 Ballad	4/4
72	03	Swing Blues	4/4
73	02	Blues	4/4
74	01	March 1	4/4
75	01	March 2	4/4
76	03	R&B	4/4
77	01	Hip-Hop	4/4
78	03	Funk	4/4
79	12	Country	4/4
80	09	Big Band	4/4
8beat			
81	03	8 Beat 1	4/4
82	05	8 Beat 2	4/4
83	03	Ballad	4/4
84	05	Hard Rock 1	4/4
85	05	Hard Rock 2	4/4
86	01	Hard Rock 3	4/4
87	03	Pop Dance 1	4/4
88	07	Pop Dance 2	4/4
89	03	R&B	4/4
16 beat			
90	01	16 beat	4/4
91	03	Fusion	4/4
Funk			
92	02	Funk 1	4/4
93	03	Funk 2	4/4
Shuffle			
94	04	Shuffle 1	4/4
95	03	Shuffle 2	4/4
96	03	16 Beat Shuffle	4/4
97	01	16 Beat Triplet	4/4
Others			
98	03	Reggae	4/4
99	12	Bossa Nova	4/4
100	08	Big Band	4/4



# Specifications

<b>Main features:</b>	7 drum pads with touch sensitivity and two pedals (kick and hi-hat)
	3-digit LED displays
	1 phones output and 1 USB jack (MIDI IN/OUT).
	25 preset drum kits,5 user drum kits.
	215 percussion voices and 128 GM voices, 8M bytes voice data
	100 songs (include 80 styles and 20 songs).
	1 demo song
	1 track recording
<b>Hand-percussion:</b>	use your hand to strike pads.
<b>Metronome:</b>	2 different voices.
<b>Dimensions:</b>	500(L)%370(W)%157.4(H)mm
<b>Net Weight:</b>	3.3kg

\*Specifications may be changed or modified at any time without prior notice

